

PRESSURE, VACUUM, DIFFERENTIAL PRESSURE,
AND TEMPERATURE SWITCHES



SIL2
CERTIFIED



DUAL SEAL
CERTIFIED

- 316 Stainless Steel Construction withstands the harshest environments
- Hermetically Sealed Micro-switch
- Vibration Resistant Belleville provides set point stability
- UL, cUL, ATEX and IECEx approved
- Dual Seal provides process sealing between electrical system and combustible process fluids

OVERVIEW

12 Series hazardous location switches are ideal for operation in tough applications where space is at a premium. A snap-action Belleville spring assembly is used in most models to provide vibration resistance and prolonged switch life. The 316 stainless steel enclosure and hermetically sealed switch provide rugged protection from the environment. Approved for use in hazardous locations worldwide, the 12 Series is installed within applications ranging from offshore oil rigs to rotating equipment, and more.

FEATURES

- UL, cUL, ATEX and IECEx approved for Div. 1 or Zone 1 hazardous locations; CE compliant
- Dual seal compliant to ANSI/ISA 12.27.01 & NEC 501.17
- Many models compliant to NACE MR0175.
- Snap-acting Belleville spring for long life, vibration resistance and stability
- Optional Hastelloy® and Monel® sensor material for corrosive media
- Mounting bracket available for retrofit applications
- 72" leadwires
- 3-year warranty

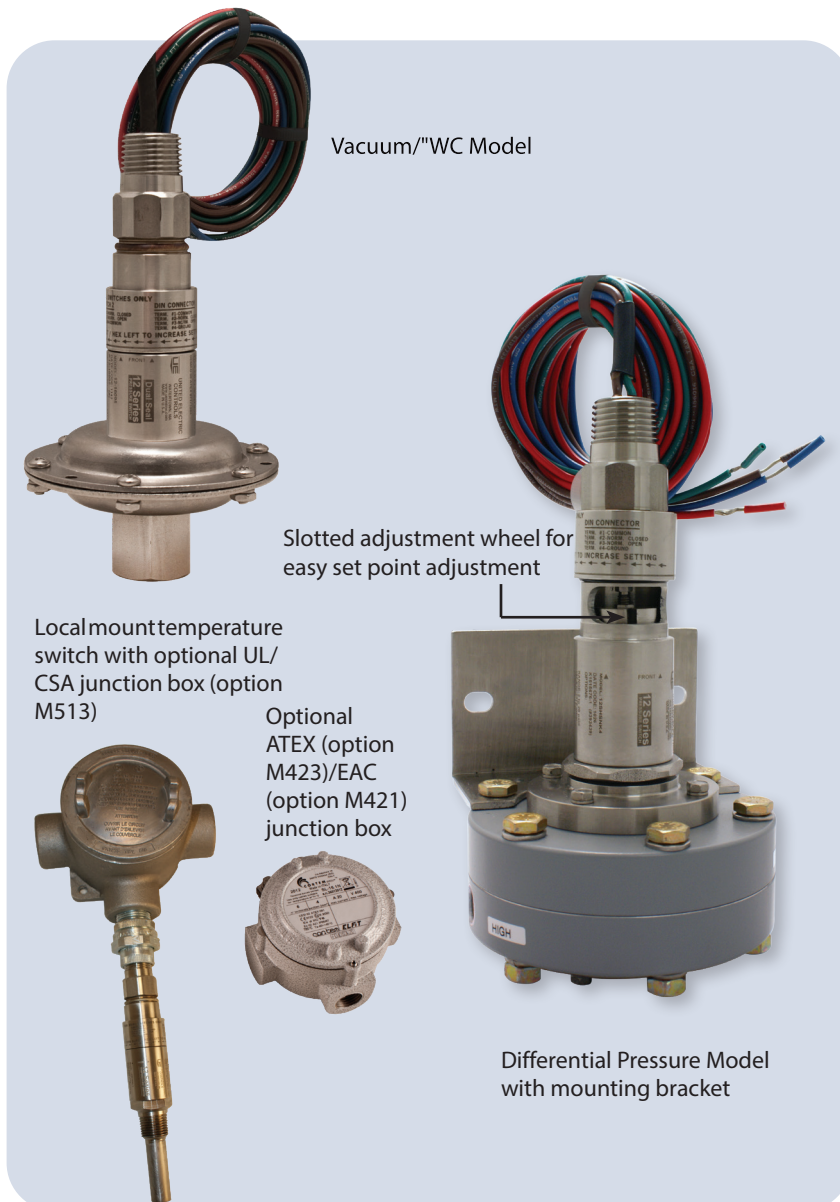

Vacuum/WC Model

Slotted adjustment wheel for easy set point adjustment

Local mount temperature switch with optional UL/CSA junction box (option M513)

Optional ATEX (option M423)/EAC (option M421) junction box

Differential Pressure Model with mounting bracket

WORLDWIDE COMPLIANCE

Quadruple approvals (UL, cUL, ATEX and IECEx) mean the 12 Series meets the demanding requirements of critical applications within hazardous locations. Additionally, the 12 Series complies with ANSI/ISA 12.27.01, "secondary seal requirements for process sealing between electrical systems and flammable or combustible process fluids," and NEC 501.17, "process sealing." It can be used in a variety of applications where space is at a premium. Metal wetted parts comply with NACE MR0175 and the 316 stainless steel, type 4X enclosure rating assure long-term performance in the harshest environments.

APPLICATIONS

Offshore Platforms



Chemical Plants & Refineries



Instrument Panels



Rotating Equipment



TECHNOLOGY

At the heart of the 12 Series is a Belleville spring assembly. The spring is a small conical washer that transfers motion to a hermetically sealed 1 or 5 amp microswitch. Its 'snap-action' provides fast, positive contact transfer. The Belleville spring 'snaps over' when pressure is applied and 'snaps back' upon pressure release.

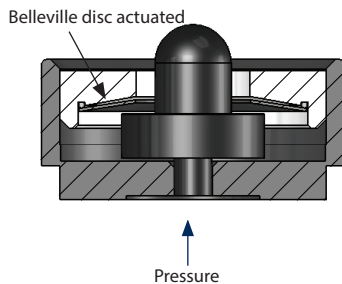

Advantages:

- **Set point stability:** The switch performs under challenging environmental conditions such as vibration and temperature changes. In addition, minimal movement of components reduces sensor fatigue, thereby increasing life and accuracy.
- **Resistance to vibration:** Preloading of the electrical switch helps reduce 'contact chatter.'
- **Small size:** Belleville springs are simple in appearance, but can deliver a heavy load with a relatively small deflection, contributing to a compact design.
- **Deadbands:** The Belleville is a 'negative-rate' snap acting device, so on-off deadband values are wider at the low end of the range. To minimize deadbands, select a model with a set point at the higher end of the range whenever possible.



SPECIFICATIONS

OPERATING AMBIENT TEMPERATURE	-58 to 176°F (-50 to 80°C); Sensor Type K: 0°F to 160°F (-18°C to 71°C). Set point shifts less than 1% of range for a 50°F (28°C) ambient temperature change. Slight ambient effects for 25-50' extra capillary length on temperature switch models, consult factory.
MEDIA TEMPERATURE	Pressure models: Sensor types 2, 7, 9: -50 to 400°F (-45 to 204°C) Sensor types 3, 4, 8: -20 to 200°F (-28 to 93°C) Sensor types 5, 6: 0 to 320°F (-18 to 160°C) Sensor type P, W: 0 to 200°F (-18 to 93°C); 20 to 250°F (-7 to 121°C) for optional Viton sensor Differential pressure models: Sensor type K: 0 to 160°F (-18 to 71°C); 20 to 250°F (-7 to 121°C) for optional Viton sensor Temperature models: See model chart (Pg. 9).
SET POINT REPEATABILITY	Temperature models: ±1% of adjustable range Pressure models: Sensor types 2, P: ±1.5% of adjustable range Sensor types 3-9, W: ±1% of adjustable range Differential pressure models: K1 to K3: ±1%, K4 to K6: ±1.5% of adjustable range
SHOCK	Differential pressure and temperature models: set point repeats after 15 G's, 10 millisecond duration Pressure models: Set point repeats after 75 G's, 10 milliseconds
VIBRATION	Differential pressure and temperature models: Set point repeats after 2.5 G's, 10-2000 Hz. Pressure models: Set point repeats after 15 G's, 10-2000 Hz
ENCLOSURE	316 stainless steel
ENCLOSURE CLASSIFICATION	Certified to Enclosure Type 4X Class I, Division 1 product meets enclosure Type 7; Class II, Division I product meets enclosure Type 9. Certified to IP66 requirements
SWITCH OUTPUT	Code S: One SPDT, hermetically sealed. Code D: Two SPDT for DPDT action, hermetically sealed. Available for pressure models only.
ELECTRICAL RATINGS	Code H: 5 A at 125/250 VAC, 5 A resistive and 3 A inductive at 28 VDC. Silver contacts Code L: 1 A at 125 VAC, 1 A resistive and 0.5 A inductive at 28 VDC Bifurcated gold contacts
ELECTRICAL CONNECTION	Code N: 1/2" NPT (male) with 72" leadwires Code M: M20 metric threads, 72" leadwires Option M515, 4 terminal DIN connector (DIN 43650 Form A) available SPDT only (does not meet Div. 1 or 2, or ATEX requirements.)
WEIGHT	Temperature models: approximately 1 lb 14 oz. (0,85 kg) Pressure models: approximately 12 ounces (0,34 kg) Vacuum, "WC models: Approximately 1lb 12 oz (0,79 kg) Differential models: K1-K3: approximately 6 lb (2,72 kg) K4-K6: approximately 4 lb (1,81 kg) K1-K3 w/ option M480: approximately 10 lb (4,55 kg) K4-K6 w/ option M480: approximately 5.5 lb (2,5 kg)

TEMPERATURE ASSEMBLY	Bulb and capillary: Non-toxic oil fill; 6 feet 304 stainless steel. Optional lengths available Immersion Stem: 316 stainless steel
TEMPERATURE DEADBAND	Typically 2% of range under laboratory conditions (70°F ambient circulating bath at a rate of 1/2°F per minute change)
PRESSURE CONNECTION	1/2" NPT (female) or 1/4" NPT (female). Differential pressure: 1/8" NPT (female) Optional pressure connection materials available, see page 12.
MOUNTING	Pressure: May be pipe mounted or bracket mounted using kit 62169-13 Differential Pressure: Should be mounted using 2 mounting holes on attached mounting bracket Temperature: Mounting kit 62169-13 should be specified for new installations

APPROVALS

UE declarations and third-party issued Agency certifications are available for download at www.ueonline.com/certs.

UNITED STATES AND CANADA

UL Listed, cUL Certified
Class I, Division 1 and 2, Groups A, B, C & D
Class II, Division 1 and 2, Groups E, F & G
Class III
Class I, Zone 1, Group IIC
Enclosure Type 4X
Pressure: UL 508 & 1203; CSA C22.2 No. 14, 25 & 30 - File # E40857
Dual seal certified to ANSI/ISA 12.27.01 (meets CEC & NEC secondary seal requirements) standard on straight pressure models only
Temperature: UL 873, 1203; CSA C22.2 No. 24, 25 & 30 - File # E43374

Canadian Registration Number (CRN): Refer to www.ueonline.com/certifications for list of approved models

EUROPEAN UNION

ATEX Directive 2014/34/EU
II 2 G Ex db IIC T6 Gb
II 2 D Ex tb IIIC T85°C Db
Tamb = -50°C to +80°C
UL International DEMKO A/S (N.B.# 0539)
Certificate # DEMKO 08 ATEX 0717128X
EN 60079-0, 60079-1, 60079-31

II 1 G Ex ia IIC T6 Ga (OPTIONAL – code M405)
Tamb = -50°C to +60°C
UL International DEMKO A/S (N.B.# 0539)
Certificate # DEMKO 11 ATEX 1105261X
EN 60079-0, 60079-11, 60079-26

Pressure Equipment Directive (PED) 2014/68/EU
Compliant to PED UL 508, UL 61010
Products rated lower than 7.5 psi are outside the scope of the PED

Low Voltage Directive (LVD) 2014/35/EU
Compliant to LVD EN 61058-1, EN 61010-1
Products rated lower than 50 VAC and 75 VDC are outside the scope of the LVD
The Low Voltage Directive does not apply to products for use in hazardous locations

UKRAINE
Gosnadzorohrantruda Permit (OPTIONAL - code M404)
1ExdIICT6X
Tamb = -56°C to +85°C
SVODOTSTVO #719 by DVSTS VE (TCCEXEE)

RUSSIA

Conforming to TR CU 012/2011 (OPTIONAL – code M406)
Certificate RU-C-US.AA87.B.00503/20
NANIO CCVE Certified
0Ex ia IIC T6 Ga X
Tamb: -50°C to +60°C
1Ex d IIC T6 Gb X
Tamb: -50°C to +80°C
ГОСТ Р МЭК 60079-0-2011; ГОСТ Р МЭК 60079-11-2010; ГОСТ IEC 60079-1-2011, ГОСТ Р МЭК 60079-31-2010; ГОСТ 31610.26-2012/IEC 60079-26-2006

INDIA

Ex d IIC T6 Gb
Tamb = -50°C to +80°C
UL International DEMKO A/S (N.B.# 0539)
Certificate # P482128/1
EN 60079-0, 60079-01, 60079-31

INTERNATIONAL CERTIFICATION* (INCLUDES AUSTRALIA)

IECEx Certified
Ex d IIC T6 Gb
Ex tb IIIC T85°C Db
Tamb. = -50°C to 80°C
IEC 60079-0, 60079-1, 60079-31
Certificate # IECEx UL 14.0072X
Ex ia IIC T6 Ga
Tamb. = -50°C ≤ Tamb ≤ 60°C
IEC 60079-0, 60079-11, 60079-26
Certificate # IECEx UL 14.0075X

Brazil

Certification accredited by INMETRO (OPTIONAL – code M391)
Ex d IIC T6 Gb
Ex tb IIIC T85°C Db
-50°C ≤ Tamb ≤ 80°C
ABNT NBR IEC 60079-0, 60079-1, 60079-31
Certificate # UL-BR 15.0174X
Ex ia IIC T6 Ga
-50°C ≤ Tamb ≤ 60°C
ABNT NBR IEC 60079-0, 60079-11, 60079-26
Certificate # UL-BR 15.0169X

* See www.iecex.com/countries.htm for a list of participating members.

MODEL CHART

Model	Adjustable Set Point Range Lower end of range on fall; High end of range on rise		Deadband		Over Range Pressure*		Proof Pressure**	
-------	--	--	----------	--	----------------------	--	------------------	--

Sensor Type 2, 316 stainless steel 1/2" NPT (female) pressure connection and welded diaphragm, 23/32" orifice for clean out purposes. High proof pressure. Not recommended for high cycling applications. Belleville actuation. (NACE MR0175 compliant with M401 option)

	psi	bar	psi	bar	psi	bar	psi	bar
A	10 to 25	0,7 to 1,7	2 to 7	0,1 to 0,5	1000	68,9	2500	172,4
B	15 to 45	1,0 to 3,1	3 to 10	0,2 to 0,7	1000	68,9	2500	172,4
C	25 to 85	1,7 to 5,9	5 to 20	0,3 to 1,4	1000	68,9	2500	172,4
D	50 to 130	3,4 to 9,0	7 to 25	0,5 to 1,7	1500	103,4	2500	172,4
E	100 to 210	6,9 to 14,5	8 to 30	0,6 to 2,1	1500	103,4	2500	172,4
F	160 to 400	11,0 to 27,6	10 to 50	0,7 to 3,4	1500	103,4	2500	172,4
G	275 to 850	19,0 to 58,6	40 to 125	2,8 to 8,6	1500	103,4	2500	172,4

Sensor Type 3, 316L stainless steel 1/2" NPT (female) pressure connection, Teflon® coated Polyimide (Kapton®) diaphragm, Buna N O-ring, 1/2" orifice for clean out purposes. Belleville actuation. (NACE MR0175 compliant with M401 option)

Sensor Type 4, 316L stainless steel 1/4" NPT (female) pressure connection, Teflon® coated Polyimide (Kapton®) diaphragm, Buna N O-ring, 1/8" orifice. Belleville actuation. (NACE MR0175 compliant with M401 option)

	psi	bar	psi	bar	psi	bar	psi	bar
A	8 to 30	0,6 to 2,1	2 to 6	0,1 to 0,4	600	41,4	1000	68,9
B	15 to 55	1,0 to 3,8	3 to 8	0,2 to 0,6	600	41,4	1000	68,9
C	30 to 170	2,1 to 11,7	5 to 15	0,3 to 1,0	600	41,4	1000	68,9
D	100 to 370	6,9 to 25,5	15 to 50	1,0 to 3,4	600	41,4	1000	68,9
E	200 to 700	13,8 to 48,3	40 to 90	2,8 to 6,2	1500	103,4	3000	206,8
F	400 to 1500	27,6 to 103,4	100 to 250	6,9 to 17,2	3000	206,8	4500	310,3
G	1000 to 3200	68,9 to 220,6	100 to 500	6,9 to 34,5	6000	413,7	10000	689,5
H	2000 to 6000	137,9 to 413,7	400 to 800	27,6 to 55,2	8000	551,6	10000	689,5

*Over Range Pressure: The maximum pressure that may be applied continuously without causing damage and maintaining set point repeatability.

**Proof Pressure: The maximum pressure to which a pressure sensor may be occasionally subjected, which causes no permanent damage. The unit may require calibration (e.g., start-up, testing).

Kalrez®, Kapton®, Teflon® & Viton® are registered trademarks of E.I. DuPont de Nemours and Company.

Hastelloy® is a registered trademark of Haynes International, Inc.

Monel® is a registered trademark of The Special Metals Corporation.

Aflas® is a registered trademark of Asahi Glass.

Model	Adjustable Set Point Range Lower end of range on fall; High end of range on rise	Deadband	Over Range Pressure*	Proof Pressure**
-------	--	----------	-------------------------	------------------

Sensor Type 5, 316L stainless steel 1/2" NPT (female) pressure connection and diaphragm, Viton® O-ring, 1/2" orifice for clean out purposes. Belleville actuation. (NACE MR0175 compliant with M401 option)

Sensor Type 6, 316L stainless steel 1/4" NPT (female) pressure connection and diaphragm, Viton® O-ring, 1/8" orifice. Belleville actuation. (NACE MR0175 compliant with M401 option)

	psi	bar	psi	bar	psi	bar	psi	bar
A	9 to 35	0,6 to 2,4	2 to 7	0,1 to 0,5	600	41,4	1000	68,9
B	25 to 65	1,7 to 4,5	3 to 10	0,2 to 0,7	600	41,4	1000	68,9
C	50 to 150	3,4 to 10,3	5 to 15	0,3 to 1,0	600	41,4	1000	68,9
D	100 to 350	6,9 to 24,1	15 to 50	1,0 to 3,4	600	41,4	1000	68,9
E	250 to 700	17,2 to 48,3	40 to 95	2,8 to 6,6	1500	103,4	3000	206,8
F	400 to 1500	27,6 to 103,4	100 to 300	6,9 to 20,7	3000	206,8	4500	310,3
G	1000 to 3200	68,9 to 220,6	100 to 500	6,9 to 34,5	6000	413,7	10000	689,5
H	2000 to 6000	137,9 to 413,7	400 to 1000	27,6 to 68,9	8000	551,6	10000	689,5

Sensor Type 7, 1/2" 316L stainless steel NPT (female) pressure connection and welded diaphragm. Large 23/32" orifice for clean out purposes. Belleville actuation. (NACE MR0175 compliant with M401 option)

	psi	bar	psi	bar	psi	bar	psi	bar
A	3 to 15	0,2 to 1,0	1 to 4	0,1 to 0,3	300	20,7	500	34,5
B	10 to 35	0,7 to 2,4	1 to 6	0,1 to 0,4	300	20,7	500	34,5
C	25 to 85	1,7 to 5,9	3 to 11	0,2 to 0,8	300	20,7	500	34,5
D	65 to 125	4,5 to 8,6	6 to 18	0,4 to 1,2	300	20,7	500	34,5

Sensor Type 8, 316L stainless steel 1/4" NPT (female) pressure connection, Teflon® coated Polyimide (Kapton®) diaphragm (optional Hastelloy® C or Monel®), Buna N O-ring (optional Kalrez®, Viton®, Ethylene Propylene, or Aflas®), 1/8" orifice. Non-Belleville actuation. (NACE MR0175 compliant with M401 option)

	psi	bar	psi	bar (unless noted)	psi	bar	psi	bar
A [†]	3 to 25	0,2 to 1,7	0.5 to 4	34,5 mbar to 0,3 bar	600	41,4	1000	68,9
B	15 to 75	1,0 to 5,2	1 to 7	0,1 to 0,5	600	41,4	1000	68,9
C	25 to 150	1,7 to 10,3	1 to 12	0,1 to 0,8	600	41,4	1000	68,9
D	50 to 450	3,4 to 31,0	3 to 36	0,2 to 2,5	2000	137,9	3000	206,8
E	100 to 900	6,9 to 62,1	10 to 60	0,7 to 4,1	2000	137,9	3000	206,8
F	500 to 2500	34,5 to 172,4	20 to 140	1,4 to 9,7	6000	413,7	7500	517,1
G	700 to 4000	48,3 to 275,8	40 to 250	2,8 to 17,2	6000	413,7	7500	517,1

Application Note: The use of metallic diaphragms where higher pressure shock or heavy cycling is expected should be avoided. Sensor Type 7 or 9 should not be used where system or startup vacuum pressure might exceed 26" Hg Vac.

***Over Range Pressure:** The maximum pressure that may be applied continuously without causing damage and maintaining set point repeatability.

****Proof Pressure:** The maximum pressure to which a pressure sensor may be occasionally subjected, which causes no permanent damage. The unit may require calibration (e.g., start-up, testing).

[†]Adjustable range is 4 to 25 psi (0,3 to 1,7 bar) for DPDT switch output



12 Series

12 Series

MODEL CHART

Model	Adjustable Set Point Range Lower end of range on fall; High end of range on rise		Deadband		Over Range Pressure*		Proof Pressure**	
Sensor Type 9, 316L stainless steel 1/2" NPT (female) pressure connection and welded diaphragm. Large 23/32" orifice for clean-out purposes. Non-Belleville actuation. (NACE MR0175 compliant with M401 option)								
	psi	bar	psi	mbar (unless noted)	psi	bar	psi	bar
A	1 to 15	0,1 to 1,0	0.5 to 2	34,5 to 137,9	300	20,7	500	34,5
B	3 to 50	0,2 to 3,4	0.5 to 4	34,5 to 275,8	300	20,7	500	34,5
C	5 to 100	0,3 to 6,9	1.0 to 8	0,1 to 06 bar	300	20,7	500	34,5
Sensor Type P, 316 stainless steel piston and Buna N O-Ring with 316 stainless steel 1/4" NPT (female) pressure connection. Non-Belleville actuation. (NACE MR0175 compliant with M401 option)								
	psi	bar	psi	bar	psi	bar	psi	bar
0	50 to 500	3,4 to 34,5	15 to 65	1,0 to 4,5	6000	413,7	10000	689,5
1	300 to 1200	20,7 to 82,7	30 to 200	2,1 to 13,8	6000	413,7	10000	689,5
2	600 to 2600	41,4 to 179,3	50 to 350	3,4 to 24,1	6000	413,7	10000	689,5
3	1200 to 5500	82,7 to 379,2	100 to 800	6,9 to 55,2	7500	517,1	10000	689,5
4	4000 to 12,500	275,8 to 861,9	300 to 1450	20,7 to 99,9	14000	965,3	16000	1103,2
Sensor Type P, 316 stainless steel piston and Buna N O-Ring with 316 stainless steel 1/4" NPT (female) pressure connection. Belleville actuation. (NACE MR0175 compliant with M401 option)								
	psi	bar	psi	bar	psi	bar	psi	bar
6	300 to 1200	20,7 to 82,7	30 to 200	2,1 to 13,8	6000	413,7	10000	689,5
7	600 to 2600	41,4 to 179,3	50 to 350	3,4 to 24,1	6000	413,7	10000	689,5
8	1200 to 5500	82,7 to 379,2	100 to 800	6,9 to 55,2	7500	517,1	10000	689,5
9	4000 to 12,500	275,8 to 861,9	300 to 1450	20,7 to 99,9	14000	965,3	16000	1103,2
Sensor Type W, 316L stainless steel 1/2" NPT (female) pressure connection and Buna N diaphragm. Non-Belleville actuation.								
	"wc (unless noted) mbar (unless noted)		"wc (unless noted) mbar		psi	bar	psi	bar
1	30 "Hg Vac to 0 psi	-1 to 0 bar	0.2 to 2 "Hg	6,8 to 67,7	75	5,2	100	6,9
2	-20 to 20	-49,9 to 49,8	0.5 to 3.5	1,2 to 8,7	75	5,2	100	6,9
3	2 to 50	5,0 to 125,5	0.5 to 5	1,2 to 12,4	75	5,2	100	6,9
4	10 to 200	24,9 to 497,8	1 to 10	2,5 to 24,9	75	5,2	100	6,9

*Over Range Pressure: The maximum pressure that may be applied continuously without causing damage and maintaining set point repeatability.

**Proof Pressure: The maximum pressure to which a pressure sensor may be occasionally subjected, which causes no permanent damage. The unit may require calibration (e.g., start-up, testing).

Application Note: The use of metallic diaphragms where higher pressure shock or heavy cycling is expected should be avoided. Sensor Type 7 to 9 should not be used where system or startup vacuum pressure might exceed 26" Hg Vac.

DIFFERENTIAL PRESSURE MODEL CHART

12 Series

Model	Adjustable Set Point Range Lower end of range on fall; High end of range on rise	Deadband	Working Pressure Range***	Proof Pressure**
-------	--	----------	---------------------------	------------------

Sensor Type K, Buna N diaphragm and sealing diaphragms with epoxy coated aluminum housing and 1/8" NPT (female) pressure connections. Non-Belleville actuation. 303/304 stainless steel mounting bracket attached.

SPDT Switch (single pole double throw)‡

	"wcd	mbar	"wc	mbar	psi (unless noted)	bar	psi	bar
1	0.7 to 10	1,7 to 24,9	0.2 to 1	0,5 to 2,5	30 "Hg Vac to 200	-1,0 to 13,8	400	27,6
2	3 to 20	7,5 to 49,8	0.3 to 1.5	0,7 to 3,7	30 "Hg Vac to 200	-1,0 to 13,8	400	27,6
3	10 to 150	24,9 to 373,4	0.3 to 5	0,7 to 12,4	30 "Hg Vac to 200	-1,0 to 13,8	400	27,6
	psid	bar	psi	bar (unless noted)	psi (unless noted)	bar	psi	bar
4	2 to 20	0,1 to 1,4	0.3 to 1.5	20,7 to 103,4 mbar	30 "Hg Vac to 1200	-1,0 to 82,7	2500	172,4
5	5 to 80	0,3 to 5,5	1 to 8	0,1 to 0,6	30 "Hg Vac to 1200	-1,0 to 82,7	2500	172,4
6	10 to 150	0,7 to 10,3	1 to 10	0,1 to 0,7	30 "Hg Vac to 1200	-1,0 to 82,7	2500	172,4

Sensor Type K, Buna N diaphragm and sealing diaphragms with epoxy coated aluminum housing and 1/8" NPT (female) pressure connections. Non-Belleville actuation. 303/304 stainless steel mounting bracket attached.

DPDT Switch (double pole double throw)‡

	"wcd	mbar	"wc	mbar	psi (unless noted)	bar	psi	bar
1	0.7 to 10	1,7 to 24,9	0.2 to 1.5	0,5 to 3,7	30 "Hg Vac to 200	-1,0 to 13,8	400	27,6
2	3 to 20	7,5 to 49,8	0.3 to 2	0,7 to 5,0	30 "Hg Vac to 200	-1,0 to 13,8	400	27,6
3	10 to 150	24,9 to 373,4	0.3 to 8	0,7 to 19,9	30 "Hg Vac to 200	-1,0 to 13,8	400	27,6
	psid	bar	psi	bar	psi	bar	psi	bar
4	2 to 20	0,1 to 1,4	0.3 to 3	20,7 to 206,8 mbar	30 "Hg Vac to 1200	-1,0 to 82,7	2500	172,4
5	5 to 80	0,3 to 5,5	1 to 10	0,1 to 0,7	30 "Hg Vac to 1200	-1,0 to 82,7	2500	172,4
6	10 to 150	0,7 to 10,3	1 to 15	0,1 to 1,0	30 "Hg Vac to 1200	-1,0 to 82,7	2500	172,4

TEMPERATURE MODEL CHART

Installation may require optional mounting bracket kit (P/N 62169-13, see page 14)

Model	Adjustable Set Point Range °F	Adjustable Set Point Range °C	Max. Temperature °F	Max. Temperature °C	Stem or Bulb Size [†]
-------	----------------------------------	----------------------------------	------------------------	------------------------	--------------------------------

Sensor Type L, 316 Stainless steel immersion stem 1/2" NPT (male). Non-Belleville actuation

1	0 to 225	-17.8 to 107.2	275	135	9/16" x 1-25/32" below thread
2	200 to 425	93.3 to 218.3	475	246.1	9/16" x 1-25/32" below thread

Sensor Type R, 304 Stainless steel bulb and capillary. Non-Belleville actuation

1	-130 to 120	-90 to 48.9	170	76.7	3/8 O.D. x 4-7/8"
2	0 to 150	-17.8 to 65.6	200	93.3	3/8 O.D. x 7-1/4"
3	50 to 300	10 to 148.9	350	176.7	3/8 O.D. x 4-7/8"
4	150 to 650	65.6 to 343.3	700	371.1	3/8 O.D. x 4"

**Proof Pressure: The maximum pressure to which a pressure sensor may be occasionally subjected, which causes no permanent damage. The unit may require calibration (e.g., start-up, testing)

*** Working Pressure Range (psi): The pressure that can be safely applied to both the high side and low side ports simultaneously while still maintaining set point adjustability. The difference in pressure between the high side and low side ports must never exceed the Adjustable Set Point Range.

‡See page 10 on building a part number for switch codes.

†Optional capillary lengths, stainless steel armored covered capillary available - consult UE. Standard capillary length is 6 ft.



12 Series

12 Series

HOW TO ORDER

Select letter or number "codes" to construct part number

Part #	12	S	H	S	N	2	A	M201			
	Series	Housing Material	Electrical Rating	Switch Output	Electrical Conduit	Sensor Type	Model	Options			
							(see next page)				
				12	S	H	S	N	2	A	M201

ORDERING CODE

DESCRIPTION

SERIES 12 DESIGNATION

12 Designation for 12 series product line

HOUSING MATERIAL

S 316 Stainless Steel

ELECTRICAL RATING*

L 1 amp

H 5 amp

SWITCH OUTPUT

S SPDT

D DPDT. Available for pressure models only.

ELECTRICAL CONDUIT

N 1/2" NPT male

M M20 metric thread

SENSOR TYPE (Belleville actuated unless noted)

- 2 Welded 316 stainless steel diaphragm, 1/2" NPT (female) pressure connection
- 3 Teflon® coated Polyimide (Kapton®) diaphragm, Buna N O-ring, 1/2" NPT (female) pressure connection
- 4 Teflon® coated Polyimide (Kapton®) diaphragm, Buna N O-ring, 1/4" NPT (female) pressure connection
- 5 316L stainless steel diaphragm, Viton® O-ring, 1/2" NPT (female) pressure connection
- 6 316L stainless steel diaphragm, Viton® O-ring, 1/4" NPT (female) pressure connection
- 7 Welded 316L stainless steel diaphragm, 1/2" NPT (female) pressure connection
- 8 Kapton® diaphragm, Buna N O-ring, 1/4" NPT (female) pressure connection (non-Belleville actuation)
- 9 316L stainless steel welded diaphragm, 1/2" NPT (female) pressure connection (non-Belleville actuation)
- P 316 stainless steel piston, Buna N O-ring, 1/4" NPT (female) 316 stainless steel pressure connections (Belleville and non-Belleville actuated models)
- W 316 Stainless steel 1/2" NPT (female) pressure connection and Buna N diaphragm (Non-Belleville actuation)
- K Buna N diaphragm and sealing diaphragm, 1/8" NPT (female) pressure connections (non-Belleville actuation)
- L Local mount, immersion stem, temperature (Non-Belleville actuated)
- R Remote mount bulb & capillary, temperature (Non-Belleville actuated)

MODELS, RANGE

A, B, C, D, E, See model chart for range specifications

F, G, H, O, 1, 2,

3, 4, 5, 6, 7, 8, 9

OPTIONS

- M201 Factory set switch, specify increasing or decreasing pressure
- M277 Range in kPa or mPa on nameplate, factory selected. NOT AVAILABLE ON TEMPERATURE VERSIONS
- M278 Range in kg/cm² on nameplate. NOT AVAILABLE ON TEMPERATURE VERSIONS
- M391 Flame proof, intrinsic safety for INMETRO compliance
- M401 NACE MR0175 wetted material compliance. AVAILABLE SENSOR TYPES 2A-F, 3A-H, 4A-H, 5A-H, 6A-H, 7A-D, 8A-G, 9A-C, P0-9. Consult factory for details on repeatability, deadband, and overpressure limits
- M404 Flameproof compliance for Ukraine per Gosnadzorohrantruda permits
- M405 European ATEX intrinsic safety compliance
- M406 Flameproof and intrinsic safety compliance per EAC standards
- M421 EAC flameproof junction box, pre-wired (not UL approved) To be ordered with M406 option. (NOT AVAILABLE ON M20 METRIC THREAD ELECTRICAL CONDUIT VERSION). THREADS TO STANDARD CONDUIT 1/2" NPT (M)
- M423 ATEX flameproof compliant junction box, pre-wired (not UL approved) (NOT AVAILABLE ON M20 METRIC THREAD ELECTRICAL CONDUIT VERSION). THREADS TO STANDARD CONDUIT 1/2" NPT (M)
- M430 Cover lock
- M444 Paper ID tag
- M446 Stainless steel ID tag and wire attachment. Text limited to 2 lines of 25 characters each, max.
- M460 External ground screw; required for non-metallic conduit systems (ATEX installations only). NOT AVAILABLE WITH OPTION M515
- M476 316 Stainless steel construction, pressure connections only; Viton® sensor material. AVAILABLE SENSOR TYPE K ONLY.
- M511 1/4" NPT (male) pressure connection for sensor types 3, 4, 5, 6 and 8 only
- M513 UL/CSA approved, explosion proof junction box, pre-wired (meets enclosure 4). NOT AVAILABLE ON M20 METRIC THREAD ELECTRICAL CONDUIT VERSION. NOT ATEX COMPLIANT.
- M515 DIN Connector-4 terminal; conforms to DIN 43650 Form A, (not approved for Class I Div. 1 & 2 or ATEX flameproof requirements). NOT AVAILABLE ON DPDT OR METRIC THREAD ELECTRICAL CONDUIT VERSIONS. NOT AVAILABLE WITH OPTION M405
- M540 Viton® wetted parts with standard pressure connection. Deadband and low end of range may increase. Available sensor types 8 (O-ring; diaphragm changes to 316L Stainless Steel), P (O-ring), K (diaphragm, O-ring and sealing diaphragms) & w (diaphragm, O-ring) only.
- M550 Oxygen service cleaned in accordance with ASTM G93, Verification type 1, tests 1 through 3. NOT AVAILABLE ON SENSOR TYPES 3 AND 4
- M924 7/16-20 SAE (female) stainless steel pressure connection. AVAILABLE SENSOR TYPE 6 ONLY

ACCESSORIES

- 62169-13 Mounting bracket kit (available with pressure and temperature models only)
- 62169-31 ATEX flameproof compliant junction box and terminal kit, not pre-wired (see option code M423 for description)
- 6361-694 Junction box and terminal kit, not pre-wired (see option code M513 for description)

OPTIONAL SENSOR MATERIALS FOR CORROSIVE MEDIA AVAILABLE SENSOR TYPE 8 ONLY

XD002	Hastelloy® C276 diaphragm NACE MR0175 compliant with M401 option
XD003	Monel® 400 diaphragm NACE MR0175 compliant with M401 option
XP112	1/2" NPT Hastelloy® C276 pressure connection NACE MR0175 compliant with M401 option
XP113	1/2" NPT Monel® 400 pressure connection NACE MR0175 compliant with M401 option
XR211	Kalrez® O-ring
XR213	Ethylene propylene O-ring
XR214	Aflas® O-ring
XR216	Viton O-ring

OPTIONS FOR TEMPERATURE MODELS

UNION CONNECTORS*

Option	Replacement Number	Description
	<u>304 Stainless Steel</u>	
W028	SD6213-28	1/2" NPT w/ 3/4" bushing
W046	SD6213-46	3/4" NPT
W050	SD6213-50	1/2" NPT

THERMOWELLS*

For all bulb & capillary switches

<u>316 Stainless Steel</u>				
W076	SD6225-76	3/4" NPT, 4.5" BT	For all immersion stem switches	
W193	SD6225-193	1/2" NPT, 4.5" BT		<u>316 Stainless Steel</u>
W119	SD6225-119	3/4" NPT, 7.5" BT	W140	SD 6225-140
W177	SD6225-177	1/2" NPT, 7.5" BT		3/4" NPT x 1-23/32" BT

OPTIONAL LENGTHS

Optional capillary length to 50' may be available in 304 st/st. Consult UE for availability, and regarding repeatability and ambient effects on capillary lengths over 30'.

304 stainless steel armor capillary protection is available to lengths less than or equal to capillary length.

*Dimensional drawings for union connectors and thermowells may be found at www.ueonline.com

DIMENSIONAL DRAWINGS

Dimensional drawings for all models may be found at www.ueonline.com

PRESSURE & TEMPERATURE SWITCH / CONNECTION CHART

Type	Description	Dimension "A"		Dimension "B"		Dimension "C"	
		Inches	mm	Inches	mm	Inches	mm
2	1/2" NPT (female)	4.4	111.1	0.7	16.5	1-1/16	27.0
3, 5	1/2" NPT (female)	4.4	111.1	0.6	15.2	1-1/16	27.0
4, 6, 8	1/4" NPT (female)	4.4	111.1	0.6	15.2	1-1/16	27.0
7, 9	1/2" NPT (female)	4.0	100.3	1.6	40.6	1-1/8	28.6
P1-P9	1/4" NPT (female)	4.4	111.1	1.0	25.4	1-1/16	27.0
W1-W2	1/2" NPT (female)	4.0	100.3	2.2	55.9	1-1/16	27.0
W3-W4	1/2" NPT (female)	4.0	100.3	1.7	42.9	1-1/16	27.0
K1-K3	1/8" NPT (female)	4.4	111.1	1.7	42.9	N/A	N/A
K4-K6	1/8" NPT (female)	4.4	111.1	1.8	44.5	N/A	N/A
L1-L2	Local Temperature	4.4	111.1	2.9	73.7	1-1/16	27.0
R1-R4	Remote Temperature	4.4	111.1	0.6	15.2	N/A	N/A

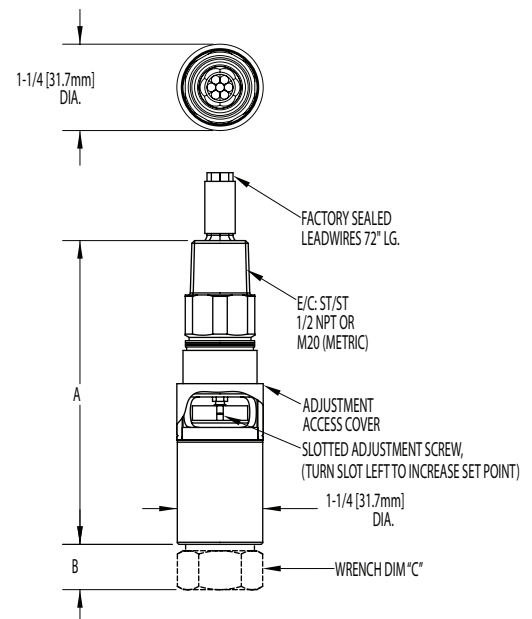

DIMENSIONAL DRAWINGS

Dimensional drawings for all models may be found at www.ueonline.com

SENSOR DETAILS

Pressure

TYPES 2, 3, 5

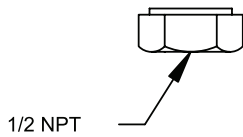

TYPES 4, 6, 8 P0-P9

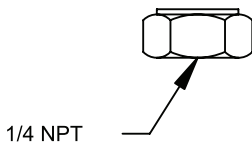

TYPES 7, 9

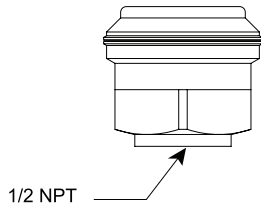

TYPE W

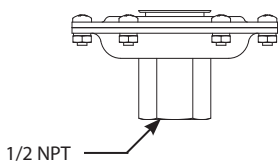

Differential Pressure (Shown with mounting bracket attached)

TYPE K1-K3

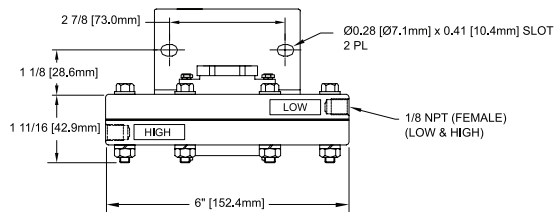

TYPES K4-K6

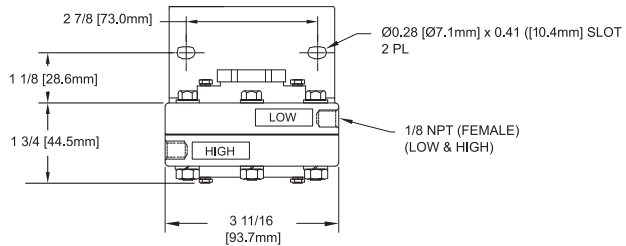

Temperature

TYPE R

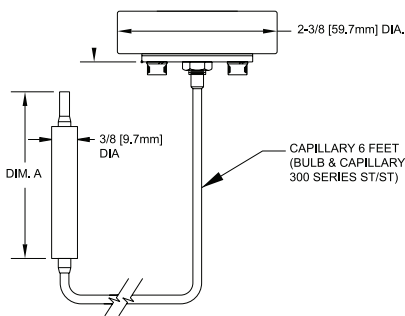

BULB DIMENSIONS		
Dimension A		
Types	Inches	mm
R1	4-7/8"	123.8
R2	7-1/4"	184.2
R3	4-7/8"	123.8
R4	4"	101.6

TYPE L

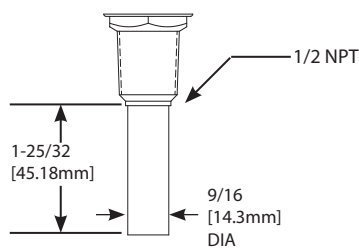

DIMENSIONAL DRAWINGS

Dimensional drawings for all models may be found at www.UEonline.com

OPTIONAL MOUNTING BRACKET KIT 62169-13

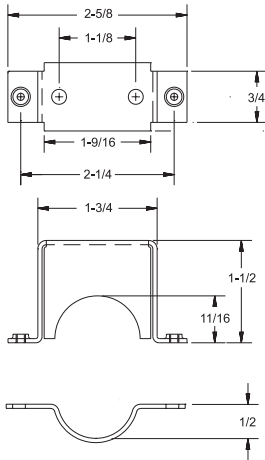

OPTION M421 & M423 JUNCTION BOX

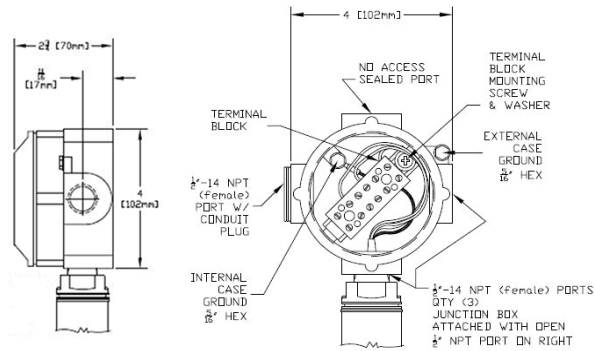

OPTION M430 COVER LOCK

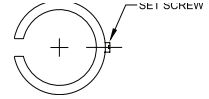

OPTION M460 EXTERNAL GROUNDING SCREW

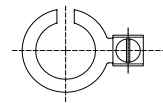

OPTION M513 JUNCTION BOX

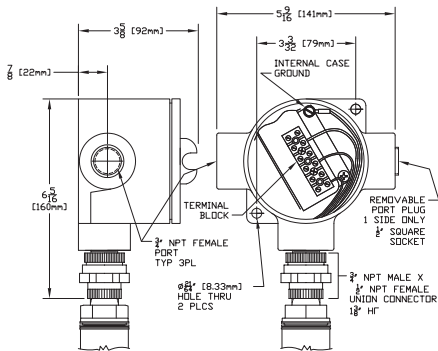

Junction box meets enclosure type 4 requirements only. Not ATEX compliant (see option M423 for ATEX junction box)

OPTION M515 DIN CONNECTOR

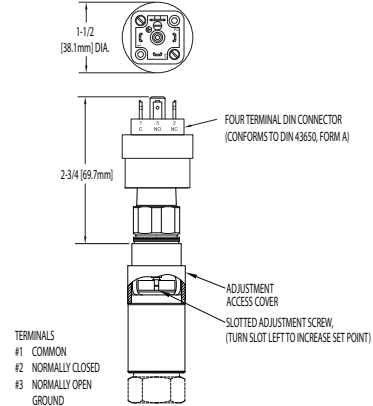

Does not meet Div 1 or 2, or ATEX requirements.

ALTERNATIVE PRODUCTS FROM UE

Vanguard Gas Detector – Toxic and Combustible Gas Detector

- WirelessHART Communication
- 5+ year battery life
- Field interchangeable toxic and combustible gas sensors
- Interoperable with existing WirelessHART networks and asset management systems (AMS)
- Easy calibration and operation
- Heavy duty design with Class 1, Div 1 & 2 hazardous location approvals



One Series Safety Transmitter for Division 1 (Zone 1)

- Combines functions of transmitter, PLC and safety relay
- Improve Uptime with safety diagnostics
- Capable of switching the final element directly
- Meet regulatory requirements with SIL2 IEC 61508 certification
- Simplify complex safety systems with SFF = 98.8



One Series for Division 1 & 2 (Zone 0, 1, 2)

- Easy and secure programming via local keypad or read-only remote HART® 7 communications
- Money-saving drop-in replacement for mechanical switches using the 2-wire switch-only version
- Achieve high reliability through IAW™ self-diagnostics and separate alarm contact
- Gain Asset Management data through HART 7 reporting
- A complete, flexible solution – 4-20mA for trending plus 2 relays for local switching - all accessible via HART® 7 Communications Protocol



120 Series

- Explosion-proof line of pressure, differential pressure, and temperature models with wide selection of ranges, sensors and pressure connections
- Div. 1, Zone 1 certified for hazardous locations
- Single or dual switch outputs
- Welded stainless steel diaphragm pressure sensor
- Internal or external set point adjustment



RECOMMENDED PRACTICES AND WARNINGS

United Electric Controls Company recommends careful consideration of the following factors when specifying and installing UE pressure transmitters. Before installing a unit, the Installation and Maintenance instructions provided with unit must be read and understood.

- To avoid damaging unit, proof pressure and maximum temperature limits stated in literature and on nameplates must never be exceeded, even by surges in the system. Operation of the unit up to maximum pressure or temperature is acceptable on a limited basis (i.e., start-up, testing) but continuous operation must be restricted to the designated adjustable range. Excessive cycling at maximum pressure or temperature limits could reduce sensor life.
- A back-up unit is necessary for applications where damage to a primary unit could endanger life, limb or property. A high or low limit switch is necessary for applications where a dangerous runaway condition could result.
- Install unit where shock, vibration and ambient temperature fluctuations will not damage unit or affect operation. When applicable, orient unit so that moisture does not enter the enclosure via the electrical connection. When appropriate, this entry point should be sealed to prevent moisture entry.
- Unit must not be altered or modified after shipment. Consult UE if modification is necessary.
- Monitor operation to observe warning signs of possible damage to unit, such as drift. Check unit immediately.
- Preventative maintenance and periodic testing is necessary for critical applications where damage could endanger property or personnel.
- Supply voltage stated in literature and on nameplate must not be exceeded. Overload on a transmitter can cause damage, even on the first cycle. Wire unit according to local and national electrical codes, using wire size recommended in installation sheet.
- Do not mount unit in ambient temp. exceeding published limits.

LIMITED WARRANTY

Seller warrants that the product hereby purchased is, upon delivery, free from defects in material and workmanship and that any such product which is found to be defective in such workmanship or material will be repaired or replaced by Seller (Ex-works, Factory, Watertown, Massachusetts. INCOTERMS); provided, however, that this warranty applies only to equipment found to be so defective within a period of 36 months from the date of manufacture by the Seller. Seller shall not be obligated under this warranty for alleged defects which examination discloses are due to tampering, misuse, neglect, improper storage, and in any case where products are disassembled by anyone other than authorized Seller's representatives. EXCEPT FOR THE LIMITED WARRANTY OF REPAIR AND REPLACEMENT STATED ABOVE, SELLER DISCLAIMS ALL WARRANTIES WHATSOEVER WITH RESPECT TO THE PRODUCT, INCLUDING ALL IMPLIED WARRANTIES OF MERCHANTABILITY OR FITNESS FOR ANY PARTICULAR PURPOSE.

LIMITATION OF SELLER'S LIABILITY

SELLER'S LIABILITY TO BUYER FOR ANY LOSS OR CLAIM, INCLUDING LIABILITY INCURRED IN CONNECTION WITH (I) BREACH OF ANY WARRANTY WHATSOEVER, EXPRESSED OR IMPLIED, (II) A BREACH OF CONTRACT, (III) A NEGLIGENT ACT OR ACTS (OR NEGLIGENT FAILURE TO ACT) COMMITTED BY SELLER, OR (IV) AN ACT FOR WHICH STRICT LIABILITY WILL BE INPUTTED TO SELLER, IS LIMITED TO THE "LIMITED WARRANTY" OF REPAIR AND/OR REPLACEMENT AS SO STATED IN OUR WARRANTY OF PRODUCT. IN NO EVENT SHALL THE SELLER BE LIABLE FOR ANY SPECIAL, INDIRECT, CONSEQUENTIAL OR OTHER DAMAGES OF A LIKE GENERAL NATURE, INCLUDING, WITHOUT LIMITATION, LOSS OF PROFITS OR PRODUCTION, OR LOSS OR EXPENSES OF ANY NATURE INCURRED BY THE BUYER OR ANY THIRD PARTY.

UE specifications subject to change without notice.

FOR A LIST OF OUR INTERNATIONAL AND DOMESTIC
REGIONAL SALES OFFICES PLEASE VISIT OUR
WEBPAGE WWW.UEONLINE.COM



UNITED ELECTRIC
CONTROLS

180 Dexter Avenue
Watertown, MA 02472 USA
Telephone: 617 926-1000 Fax: 617 926-2568
<http://www.ueonline.com>

CP0913250