

## MODEL CUB5 - MINIATURE ELECTRONIC 8-DIGIT DUAL COUNTER AND RATE INDICATOR



- LCD, REFLECTIVE OR GREEN/RED LED BACKLIGHTING
- 0.46" (11.7 mm) HIGH DIGITS
- OPTIONAL RELAY OUTPUT MODULE
- COUNT SPEEDS UP TO 20 KHZ
- OPERATES FROM 9 TO 28 VDC POWER SOURCE
- PROGRAMMABLE SCALING FOR COUNT AND RATE
- BI-DIRECTIONAL COUNTING, UP/DOWN CONTROL
- QUADRATURE SENSING (UP TO 4 TIMES RESOLUTION)
- ANTI-COINCIDENCE COUNTING (ADD/ADD & ADD/SUB)
- NEMA 4X/IP65 SEALED FRONT BEZEL

### GENERAL DESCRIPTION

The CUB5 provides the user the ultimate in flexibility, from its complete user programming to the optional relay output capability. The meter can be programmed as a single or dual counter with rate indication capability. The display can be toggled either manually or automatically between the selected displays.

The CUB5 display has 0.46" (11.7 mm) high digits. The LCD is available in two versions, reflective (CUB5R000) and backlight (CUB5B000). The backlight version is user selectable for green or red backlighting with variable display intensity.

The counter is programmable for one of eight different count modes, including bi-directional and quadrature. When programmed as a dual counter, each counter has a separate scale factor and decimal points. In the counter/rate indicator mode, each has their own scaling and decimal point read-outs in different engineering units.

The meter has two separate inputs which provide different functions depending on which operating mode is selected. Input A accepts the signal for the Count and or Rate displays, while Input B accepts the signal for the Count display or direction control. In the anti-coincidence mode, both inputs are monitored simultaneously so that no counts are lost. The resulting display can be chosen as the sum or difference of the two inputs. The Rate Indicator has programmable low (minimum) and high (maximum) update times to provide optimal display response at any input frequency. There is a programmable user input that can be programmed to perform a variety of functions.

The capability of the CUB5 can be easily expanded with the addition of an option module. Setpoint capability is field installable with the addition of the CUB5RLY0, relay output module.

The CUB5 can be powered from an optional Red Lion Micro-Line/Sensor Power Supply (MLPS1000), which attaches directly to the back of a CUB5. The MLPS1 is powered from 85 to 250 VAC and provides up to 400 mA to drive the unit and sensors.

### COUNTER

The CUB5 receives incoming pulses and multiplies them by the Count Scale Factor to obtain the desired reading for the count display. Input A accepts the signal for the count and Input B is used for quadrature, dual counter, anti-coincidence counting, or up/down control counting.

### RATE

The rate indicator utilizes the signal at Input A to calculate the rate value using a time interval method (1/tau). The unit counts on the negative edge of the input pulses. After the programmed minimum update time elapses and the next negative edge occurs, the unit calculates the input rate based on the number of edges that occurred during the elapsed time. The input rate is then multiplied by the rate scaling value to calculate the rate display.

At slower rates, averaging can be accomplished by programming the rate minimum update time for the desired response. Extensive scaling capabilities allow practically any desired reading at very slow count rates.

### SAFETY SUMMARY

All safety related regulations, local codes and instructions that appear in this literature or on equipment must be observed to ensure personal safety and to prevent damage to either the instrument or equipment connected to it. If equipment is used in a manner not specified by the manufacturer, the protection provided by the equipment may be impaired.

Do not use this meter to directly command motors, valves, or other actuators not equipped with safeguards. To do so can be potentially harmful to persons or equipment in the event of a fault to the meter.



CAUTION: Read complete instructions prior to installation and operation of the unit.



CAUTION: Risk of electric shock.

### DIMENSIONS In inches (mm)

Note: Recommended minimum clearance (behind the panel) for mounting clip installation is 2.15" (54.6) H x 3.00" (76.2) W.

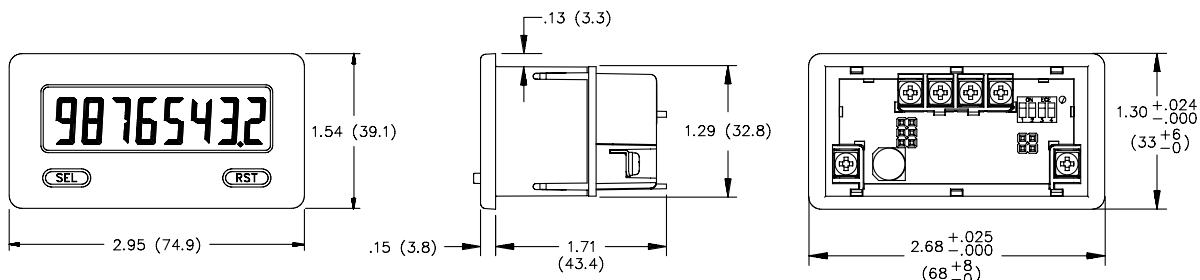

# ORDERING INFORMATION

TYPE	MODEL NO.	DESCRIPTION	PART NUMBER
CUB5	CUB5R	Dual Counter & Rate Indicator with Reflective Display	CUB5R000
	CUB5B	Dual Counter & Rate Indicator with Backlight Display	CUB5B000
Optional Plug-in Cards	CUB5RLY	Single Relay Option Card	CUB5RLY0
Accessory	MLPS1	Micro-Line Power Supply, 85 to 250 VAC	MLPS1000

# GENERAL METER SPECIFICATIONS

- DISPLAY:** 8 digit LCD 0.46" (11.7 mm) high digits  
**CUB5R000:** Reflective LCD with full viewing angle  
**CUB5B000:** Selectable transmissive red or green backlight LED with viewing angle optimized.
- POWER:** Input voltage range is +9 to +28 VDC with short circuit and input polarity protection. Must use an RLC model MLPS1 or a Class 2 or SELV rated power supply.

MODEL NUMBER	DISPLAY COLOR	INPUT CURRENT WITHOUT CUB5RLY0	INPUT CURRENT WITH CUB5RLY0
CUB5R000	---	10 mA	30 mA
CUB5B000	Red (max intensity)	85 mA	115 mA
CUB5B000	Green (max intensity)	95 mA	125 mA

- COUNTER DISPLAYS:**  
**Counter A:** 8-digits, enabled in all count modes  
 Display Range: -9999999 to 99999999  
 Overflow Indication: Display flashes "Erl EEr"  
**Counter B:** 7-digits, enabled in Dual Counter mode only  
 Display Designator: "b" to the left side of the display  
 Display Range: 0 to 9999999 (positive count only)  
 Overflow Indication: Display flashes "bErl EEr"  
**Maximum Count Rates:** 50% duty cycle  
 Without setpoint option card: 20 KHz (all count modes)  
 With setpoint option card: 20 KHz for any count mode except Quadrature x4 (18 KHz) and Dual Counter (17 KHz)
- RATE DISPLAY:** 6-digits, may be enabled or disabled in any mode  
**Display Designator:** "R" to the left side of the display  
**Display Range:** 0 to 999999  
**Over Range Display:** "R RLRL"  
**Maximum Frequency:** 20 KHz  
**Minimum Frequency:** 0.01 Hz  
**Accuracy:** ±0.01%
- COUNT/RATE SIGNAL INPUTS (INP A and INP B):**  
**Input A:** DIP switch selectable to accept pulses from a variety of sources.  
 See Section 2.0 Setting the DIP Switches for Input A specifications.  
**Input B:** Logic signals only  
 Trigger levels:  $V_{IL} = 1.0$  V max;  $V_{IH} = 2.4$  V min;  $V_{MAX} = 28$  VDC  
 Current sinking: Internal 10KΩ pull-up resistor to +9 to 28 VDC  
 Filter (LO Freq.): Damping capacitor provided for switch contact bounce.  
 Limits input frequency to 50 Hz and input pulse widths to 10 msec min.
- USER INPUT (USER):** Programmable input. Connect terminal to common to activate function. Internal 10KΩ pull-up resistor to +9 to 28 VDC.  
**Threshold Levels:**  $V_{IL} = 1.0$  V max;  $V_{IH} = 2.4$  V min;  $V_{MAX} = 28$  VDC  
**Response Time:** 5 msec typ.; 50 msec debounce (activation and release)
- MEMORY:** Nonvolatile E<sup>2</sup>PROM memory retains all programming parameters and count values when power is removed.
- ENVIRONMENTAL CONDITIONS:**  
**Operating Temperature Range for CUB5R000:** -35 to 85°C  
**Operating Temperature Range for CUB5B000 depends on display color and intensity level as per below:**

	INTENSITY LEVEL	TEMPERATURE
Red Display	1 & 2	-35 to 75°C
	3	-35 to 70°C
	4	-35 to 60°C
	5	-35 to 50°C
	Green Display	1 & 2
	3	-35 to 65°C
	4	-35 to 50°C
	5	-35 to 35°C

**Storage Temperature:** -35 to 85°C  
**Operating and Storage Humidity:** 0 to 85% max. relative humidity (non-condensing)

**Altitude:** Up to 2000 meters

## 9. CERTIFICATIONS AND COMPLIANCES:

### SAFETY

IEC 1010-1, EN 61010-1: Safety requirements for electrical equipment for measurement, control, and laboratory use, Part 1.

IP65 Enclosure rating (Face only), IEC 529

Type 4X Enclosure Rating (Face only), UL50

### ELECTROMAGNETIC COMPATIBILITY

Emissions and Immunity to EN 61326: Electrical Equipment for Measurement, Control and Laboratory use.

### Immunity to Industrial Locations:

Electrostatic discharge	EN 61000-4-2	Criterion A 4 kV contact discharge 8 kV air discharge
Electromagnetic RF fields	EN 61000-4-3	Criterion A 10 V/m
Fast transients (burst)	EN 61000-4-4	Criterion A 2 kV power 1 kV signal
Surge	EN 61000-4-5	Criterion A 1 kV L-L, 2 kV L&N-E power
RF conducted interference	EN 61000-4-6	Criterion A 3 V/rms
Power frequency magnetic fields	EN 61000-4-8	Criterion A 30 A/m

### Emissions:

Emissions	EN 55011	Class A
-----------	----------	---------

### Notes:

1. *Criterion A: Normal operation within specified limits.*

2. *Criterion B: Temporary loss of performance from which the unit self-recovers.*

Refer to EMC Installation Guidelines for additional information.

## 10. CONNECTIONS:

Wire clamping screw terminals

**Wire Strip Length:** 0.3" (7.5 mm)

**Wire Gauge:** 30-14 AWG copper wire

**Torque:** 5 inch-lbs (0.565 N-m) max.

- CONSTRUCTION:** This unit is rated for NEMA 4X/IP65 requirements for indoor use. Installation Category I, Pollution Degree 2. High impact plastic case with clear viewing window. Panel gasket and mounting clip included.
- WEIGHT:** 3.2 oz (100 g)

# OPTIONAL PLUG-IN OUTPUT CARD

## Adding Option Card

The CUB5 meters can be fitted with an optional relay card. The details for the plug-in card can be reviewed in the specification section below. The plug-in card can be installed initially or at a later date.



**WARNING: Disconnect all power to the unit before installing Plug-in card.**

### RELAY CARD

**Type:** Single FORM-C relay

**Isolation To Sensor & User Input Commons:** 1400 Vrms for 1 min.

Working Voltage: 150 Vrms

**Contact Rating:** 1 amp @ 30 VDC resistive; 0.3 amp @ 125 VAC resistive

**Life Expectancy:** 100,000 minimum operations

**Response Time:**

Turn On Time: 4 msec max.

Turn Off Time: 4 msec max.

**Time Accuracy:**  $\pm 0.01\%$

## 1.0 INSTALLING THE METER

### Installation

The meter meets NEMA 4X/IP65 requirements when properly installed. The unit is intended to be mounted into an enclosed panel. Prepare the panel cutout to the dimensions shown. Remove the panel latch from the unit. Slide the panel gasket over the rear of the unit to the back of the bezel. The unit should be installed fully assembled. Insert the unit into the panel cutout.

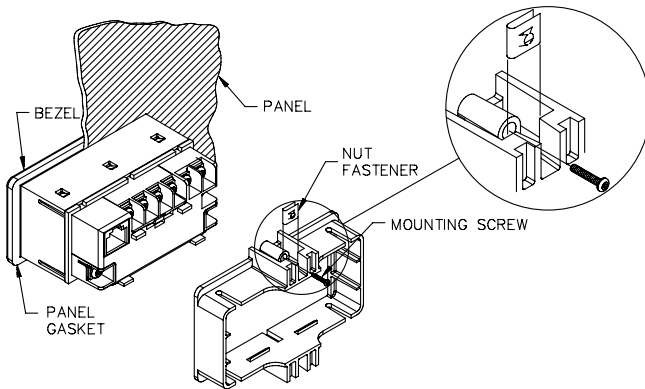

While holding the unit in place, push the panel latch over the rear of the unit so that the tabs of the panel latch engage in the slots on the case. The panel latch should be engaged in the farthest forward slot possible. To achieve a proper seal, tighten the latch screws evenly until the unit is snug in the panel (Torque to approx. 28 to 36 in-oz [0.202 to 0.26 N-m]). Do not over-tighten the screws.

### Installation Environment

The unit should be installed in a location that does not exceed the operating temperature and provides good air circulation. Placing the unit near devices that generate excessive heat should be avoided.

The bezel should only be cleaned with a soft cloth and neutral soap product. Do NOT use solvents. Continuous exposure to direct sunlight may accelerate the aging process of the bezel.

Do not use tools of any kind (screwdrivers, pens, pencils, etc.) to operate the keypad of the unit.

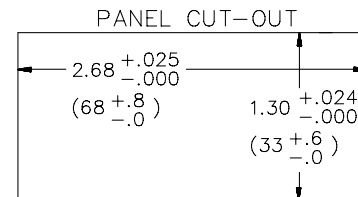

## 2.0 SETTING THE DIP SWITCHES

To access the switches, remove the rear cover of the meter. A bank of 4 switches is located in the upper right hand corner.



**Warning:** Exposed line voltage exists on the circuit boards. Remove all power to the meter and load circuits before accessing inside of the meter.

### REMOVING THE REAR COVER

To remove the rear cover, locate the cover locking tab below the 2nd and 3rd input terminals. To release the tab, insert a small, flat blade screwdriver between the tab and the plastic wall below the terminals. Inserting the screwdriver will provide enough pressure to release the tab locks. To replace the cover, align the cover with the input terminals and press down until the cover snaps into place.

### SETTING THE INPUT DIP SWITCHES

The meter has four DIP switches for Input A and Input B that must be set before applying power.

#### SWITCH 1

**LOGIC:** Input A trigger levels  $V_{IL} = 1.25$  V max.;  $V_{IH} = 2.75$  V min.;  $V_{MAX} = 28$  VAC

**MAG:** 200 mV peak input sensitivity; 100 mV hysteresis; maximum voltage:  $\pm 40$  V peak (28 Vrms); Must also have SRC switch ON. (Not recommended with counting applications.)

#### SWITCH 2

**SNK:** Adds internal 7.8 K $\Omega$  pull-up resistor to +9 to 28 VDC,  $I_{MAX} = 3.8$  mA.

**SRC:** Adds internal 3.9 K $\Omega$  pull-down resistor, 7.2 mA max. @ 28 VDC max.

#### SWITCHES 3 and 4

**HI Frequency:** Removes damping capacitor and allows max. frequency.

**LO Frequency:** Adds a damping capacitor for switch contact bounce. Limits input frequency to 50 Hz and input pulse widths to 10 msec.

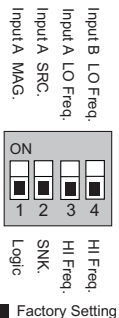

■ Factory Setting

# 3.0 INSTALLING PLUG-IN CARD

The Plug-in card is separately purchased optional card that performs specific functions. The card plugs into the main circuit board of the meter.

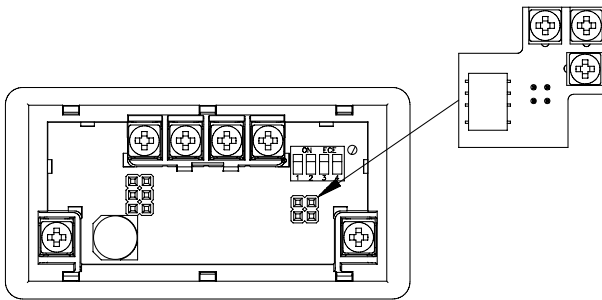

**CAUTION:** The Plug-in card and main circuit board contain static sensitive components. Before handling the cards, discharge static charges from your body by touching a grounded bare metal object. Ideally, handle the cards at a static controlled clean workstation. Also, only handle the cards by the edges. Dirt, oil or other contaminants that may contact the cards can adversely affect circuit operation.

# 4.0 WIRING THE METER

## WIRING OVERVIEW

Electrical connections are made via screw-clamp terminals located on the back of the meter. All conductors should conform to the meter's voltage and current ratings. All cabling should conform to appropriate standards of good installation, local codes and regulations. It is recommended that the power supplied to the meter (DC or AC) be protected by a fuse or circuit breaker.

Strip the wire, leaving approximately 0.3" (7.5 mm) bare lead exposed (stranded wires should be tinned with solder.) Insert the lead under the correct screw-clamp terminal and tighten until the wire is secure. (Pull wire to verify tightness.) Each terminal can accept up to one #14 AWG (2.55 mm) wire, two #18 AWG (1.02 mm), or four #20 AWG (0.61 mm).

## EMC INSTALLATION GUIDELINES

Although this meter is designed with a high degree of immunity to Electro-Magnetic Interference (EMI), proper installation and wiring methods must be followed to ensure compatibility in each application. The type of the electrical noise, source or coupling method into the meter may be different for various installations. The meter becomes more immune to EMI with fewer I/O connections. Cable length, routing, and shield termination are very important and can mean the difference between a successful or troublesome installation. Listed below are some EMC guidelines for successful installation in an industrial environment.

1. The meter should be mounted in a metal enclosure, which is properly connected to protective earth.
2. Use shielded (screened) cables for all Signal and Control inputs. The shield (screen) pigtail connection should be made as short as possible. The connection point for the shield depends somewhat upon the application. Listed below are the recommended methods of connecting the shield, in order of their effectiveness.
  - a. Connect the shield only at the panel where the unit is mounted to earth ground (protective earth).
  - b. Connect the shield to earth ground at both ends of the cable, usually when the noise source frequency is above 1 MHz.
  - c. Connect the shield to common of the meter and leave the other end of the shield unconnected and insulated from earth ground.
3. Never run Signal or Control cables in the same conduit or raceway with AC power lines, conductors feeding motors, solenoids, SCR controls, and heaters, etc. The cables should be ran in metal conduit that is properly grounded. This is especially useful in applications where cable runs are long and portable two-way radios are used in close proximity or if the installation is near a commercial radio transmitter.
4. Signal or Control cables within an enclosure should be routed as far as possible from contactors, control relays, transformers, and other noisy components.
5. In extremely high EMI environments, the use of external EMI suppression devices, such as ferrite suppression cores, is effective. Install them on Signal and Control cables as close to the unit as possible. Loop the cable through the core several times or use multiple cores on each cable for additional protection. Install line filters on the power input cable to the unit to suppress power line interference. Install them near the power entry point of the enclosure. The following EMI suppression devices (or equivalent) are recommended:
  - Ferrite Suppression Cores for signal and control cables:
    - Fair-Rite # 0443167251 (RLC# FCOR0000)
    - TDK # ZCAT3035-1330A
    - Steward # 28B2029-0A0
  - Line Filters for input power cables:
    - Schaffner # FN610-1/07 (RLC# LFIL0000)
    - Schaffner # FN670-1.8/07
    - Corcom # 1 VR3

*Note: Reference manufacturer's instructions when installing a line filter.*
6. Long cable runs are more susceptible to EMI pickup than short cable runs. Therefore, keep cable runs as short as possible.
7. Switching of inductive loads produces high EMI. Use of snubbers across inductive loads suppresses EMI.
  - Snubber: RLC# SNUB0000.

## 4.1 POWER WIRING

### DC Power

+9 to +28 VDC: +VDC  
Power Common: -VDC

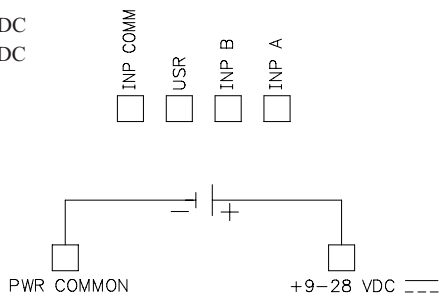

## 4.2 USER INPUT WIRING

### Sinking Logic

INP COMM } Connect external switching device between the  
USR } User Input terminal and Input Common.

The user input of the meter is internally pulled up to +9 to +28 V with 10 K resistance. The input is active when it is pulled low (<0.7 V).

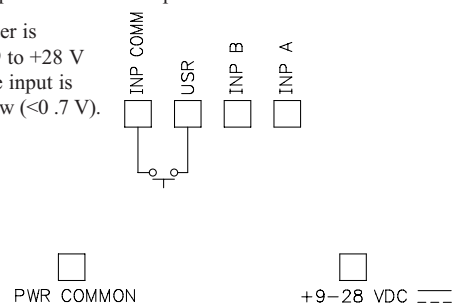

## 4.3 INPUT WIRING



**CAUTION:** Power input common is NOT isolated from user input common. In order to preserve the safety of the meter application, the power input common must be suitably isolated from hazardous live earth referenced voltage; or input common must be at protective earth ground potential. If not, hazardous voltage may be present at the User Inputs and User Input Common terminals. Appropriate considerations must then be given to the potential of the user input common with respect to earth ground; and the common of the plug-in cards with respect to input common.

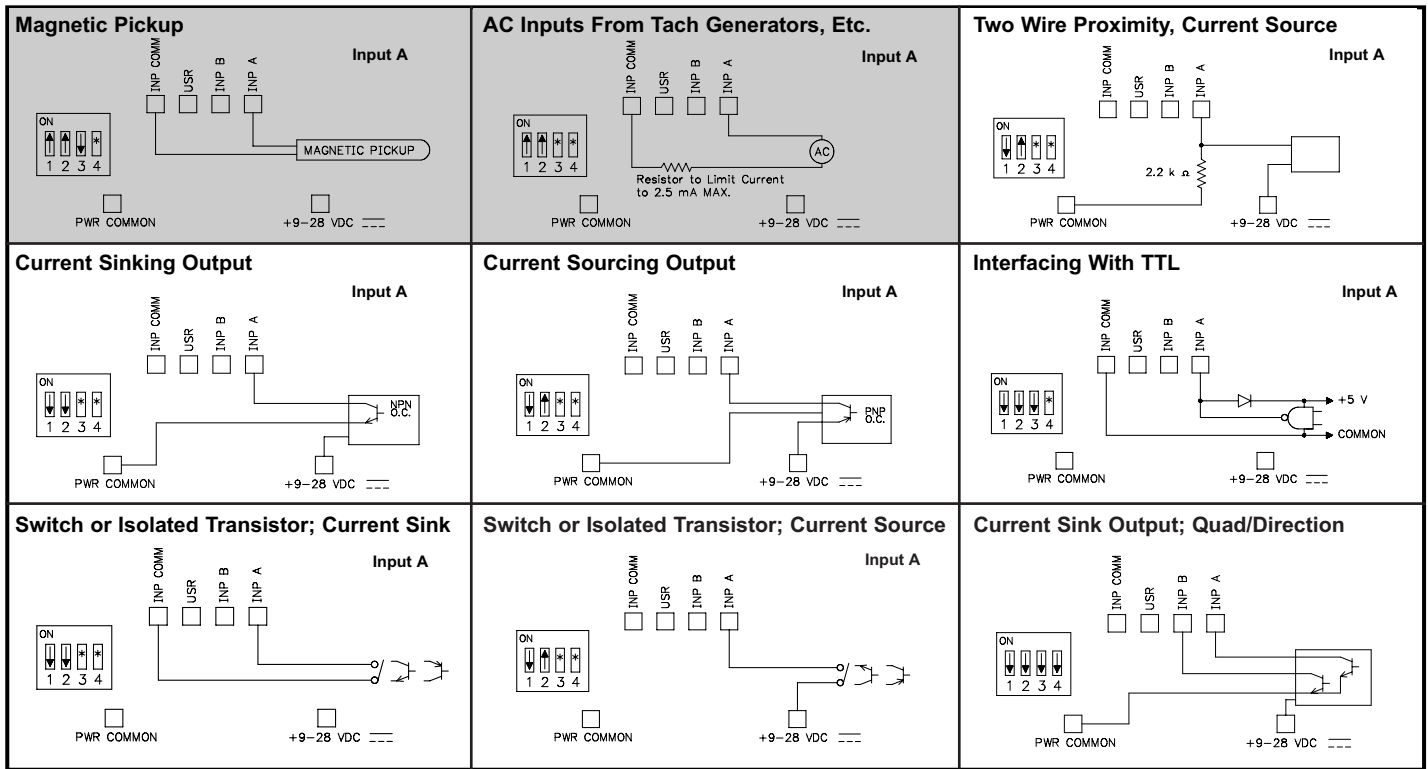

\* Switch position is application dependent.

Shaded areas not recommended for counting applications.

## 4.4 SETPOINT (OUTPUT) WIRING

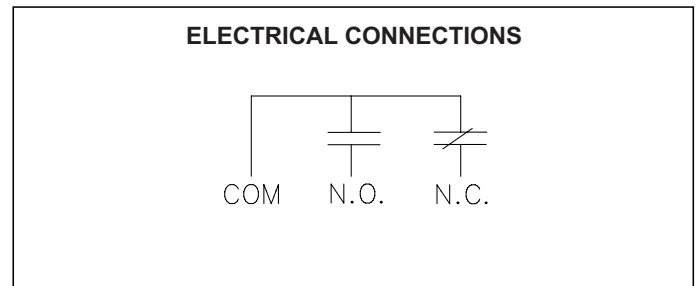
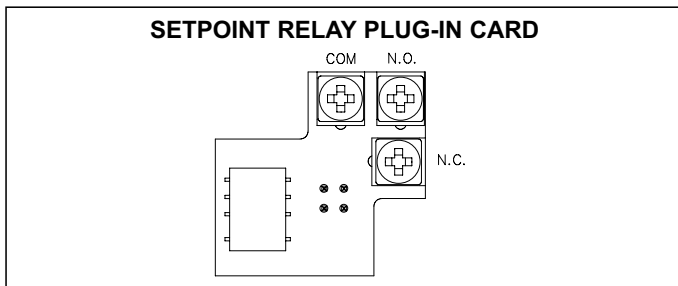

# 5.0 REVIEWING THE FRONT BUTTONS AND DISPLAY

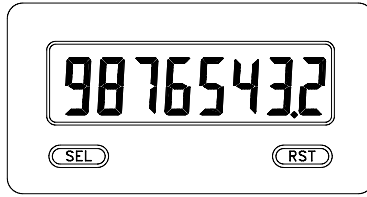

KEY	DISPLAY MODE OPERATION	ENTERING PROGRAM MODE	PROGRAMMING MODE OPERATION
SEL	Index display through selected displays	Press and hold for 2 seconds to activate	Store selected parameter and index to next parameter
RST	Resets count display	Press SEL to enter programming mode	Advances through the program menu/Increments selected parameter value or selection

## OPERATING MODE DISPLAY DESIGNATORS

“R” - To the left of the display is the rate value.  
 - Counter A has no designator.

“b” - To the left of the display is the Counter B value.  
 “1” - To the left of the display indicates the setpoint status.

Pressing the **SEL** button toggles the meter through the selected displays. If display scroll is enabled, the display will toggle automatically approximately every four seconds between the rate and count values.

# 6.0 PROGRAMMING THE METER

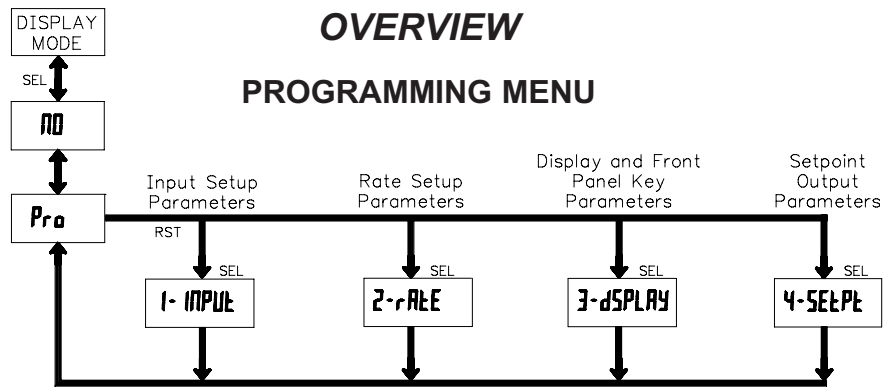

## PROGRAMMING MODE ENTRY (SEL KEY)

It is recommended all programming changes be made off line, or before installation. The meter normally operates in the Display Mode. No parameters can be programmed in this mode. The Programming Mode is entered by pressing and holding the **SEL** key. If it is not accessible then it is locked by either a security code, or a hardware lock.

## MODULE ENTRY (SEL & RST KEYS)

The Programming Menu is organized into four modules. These modules group together parameters that are related in function. The display will alternate between **Pr0** and the present module. The **RST** key is used to select the desired module. The displayed module is entered by pressing the **SEL** key.

## MODULE MENU (SEL KEY)

Each module has a separate module menu (which is shown at the start of each module discussion). The **SEL** key is pressed to advance to a particular parameter to be changed, without changing the programming of preceding parameters. After completing a module, the display will return to **Pr0 00**. Programming may continue by accessing additional modules.

## SELECTION / VALUE ENTRY

For each parameter, the display alternates between the present parameter and the selections/value for that parameter. The **RST** key is used to move through the selections/values for that parameter. Pressing the **SEL** key, stores and activates the displayed selection/value. This also advances the meter to the next parameter.

For numeric values, press the **RST** key to access the value. The right hand most digit will begin to flash. Pressing the **RST** key again increments the digit by one or the user can hold the **RST** key and the digit will automatically scroll. The **SEL** key will advance to the next digit. Pressing and holding the **SEL** key will enter the value and move to the next parameter.

## PROGRAMMING MODE EXIT (SEL KEY)

The Programming Mode is exited by pressing the **SEL** key with **Pr0 00** displayed. This will commit any stored parameter changes to memory and return the meter to the Display Mode. (If power loss occurs before returning to the Display Mode, verify recent parameter changes.)

## PROGRAMMING TIPS

It is recommended to start with Module 1 for counting or Module 2 for rate. When programming is complete, it is recommended to record the parameter programming and lock out parameter programming with the user input or programming security code.

## FACTORY SETTINGS

Factory Settings may be completely restored in Module 3. This is useful when encountering programming problems.

Pressing the **RST** key on power-up will load the factory settings and display **rESEt**. This allows operation in the event of a memory failure or corrupted data.

## ALTERNATING SELECTION DISPLAY

In the explanation of the modules, the following dual display with arrows will appear. This is used to illustrate the display alternating between the parameter on top and the parameter's Factory Setting on the bottom. In most cases, selections and values for the parameter will be listed on the right.

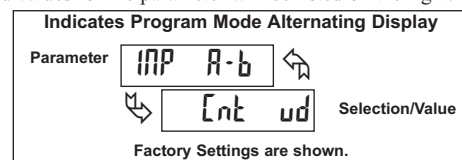

# 6.1 MODULE 1 - INPUT SETUP PARAMETERS (I- INPUT)

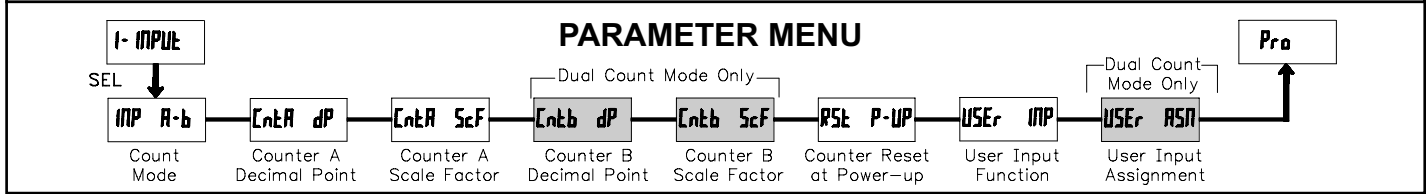

Shaded area selections only apply when programmed for dual count mode.

## COUNT MODE

INP A-b

Cnt ud

RRtE Cnt

dUAL Cnt

QUAd 1

QUAd 2

QUAd 4

Add Add

Add Sub

Select the count mode that corresponds with your application. The input actions are shown in the boxes below. For simple counting applications, it is recommended to use Count with Direction for the count mode. Simply leave the direction input unconnected.

DISPLAY	MODE	INPUT A ACTION	INPUT B ACTION
Cnt ud	Count with Direction	Counter A	Counter A Direction
RRtE Cnt	Rate/Counter	Rate only	Counter A Add
dUAL Cnt	Dual Counter	Counter A Add	Counter B Add
QUAd 1	Quadrature x1	Count A	Quad A
QUAd 2	Quadrature x2	Count A	Quad A
QUAd 4	Quadrature x4	Count A	Quad A
Add Add	2 Input Add/Add	Counter A Add	Counter A Add
Add Sub	2 Input Add/Subtract	Counter A Add	Counter A Subtract

Note: The Rate indicator signal is derived from Input A in all count modes.

## COUNTER A DECIMAL POSITION

CntA dP

0

00

000

00000

This selects the decimal point position for Counter A and the setpoint value, if assigned to Counter A. The selection will also affect Counter A scale factor calculations.

## COUNTER A SCALE FACTOR

CntA ScF

0.0000

00000.1 to 999999

The number of input counts is multiplied by the scale factor to obtain the desired process value. A scale factor of 1.0000 will result in the display of the actual number of input counts. (Details on scaling calculations are explained at the end of this section.)\*

## COUNTER B DECIMAL POSITION

Cntb dP

0

00

000

00000

This selects the decimal point position for Counter B. The selection will also affect Counter B scale factor calculations.

## COUNTER B SCALE FACTOR

Cntb ScF

0.0000

00000.1 to 999999

The number of input counts is multiplied by the scale factor to obtain the desired process value. A scale factor of 1.0000 will result in the display of the actual number of input counts. (Details on scaling calculations are explained at the end of this section.)\*

## COUNTER RESET AT POWER-UP

RSt P-UP

NO

YES

Count b

Count A both A-b

## SCALING FOR COUNT INDICATION

The CUB5's scale factor is factory set to 1, to provide one count on the display for each pulse that is input to the unit. In many applications, there will not be a one-to-one correspondence between input pulses and display units. Therefore, it is necessary for the CUB5 to scale or multiply the input pulses by a scale factor to achieve the desired display units (feet, meters, gallons, etc.)

The Count Scale Factor Value can range from 00.0001 to 99.9999. It is important to note that the precision of a counter application cannot be improved by using a scale factor greater than one. To accomplish greater precision, more pulse information must be generated per measuring unit. The following formula is used to calculate the scale factor.

$$\text{Scale Factor} = \frac{\text{Desired Display Units}}{\text{Number of Pulses}} \times \text{Decimal Point Position}$$

### WHERE:

**Desired Display Units:** Count display units acquired after pulses that occurred.

**Number of Pulses:** Number of pulses required to achieve the desired display units.

### Decimal Point Position:

0	=	1
0.0	=	10
0.00	=	100
0.000	=	1000
0.0000	=	10000
0.00000	=	100000

**EXAMPLE:** The counter display is used to indicate the total number of feet used in a process. It is necessary to know the number of pulses for the desired units to be displayed. The decimal point is selected to show the resolution in hundredths.

$$\text{Scale Factor} = \frac{\text{Desired Display Units}}{\text{Number of Pulses}} \times \text{Decimal Point Position}$$

Given that 128 pulses are equal to 1 foot, display total feet with a one-hundredth resolution.

$$\text{Scale Factor} = \frac{1.00}{128} \times 100$$

$$\text{Scale Factor} = 0.007812 \times 100$$

$$\text{Scale Factor} = 0.7812$$

\*For value entry instructions, refer to selection/value entry in the Programming The Meter section.

## USER INPUT FUNCTION

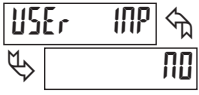

DISPLAY	MODE	DESCRIPTION
NO	No Function	User Input disabled.
Pro Loc	Program Mode Lock-out	See Programming Mode Access chart.
d-SELECT	Display Select (Edge triggered)	Advance once for each activation.
rESEt	Maintained Reset	Level active reset of the selected counters.
StorE	Store	Freeze display for the selected counter(s) while allowing counts to accumulate internally.
Stor-rSt	Store and Reset	Edge triggered reset of the selected counter(s) after storing the count.
Inh ib it	Inhibit	Inhibit counting for the selected counter(s).
d-LEVEL	Display Intensity Level (Edge Triggered)	Increase intensity one level for each activation. (backlight version only)

## PROGRAMMING MODE ACCESS

SECURITY CODE	USER INPUT FUNCTION	USER INPUT STATE	PROGRAMMING MODE ACCESS
0	not Pro Loc	----	Immediate access
>0	not Pro Loc	----	After entering security code at Pro LocE prompt *
>0	Pro Loc	Active	After entering security code at Pro LocE prompt *
>0	Pro Loc	Not Active	Immediate access
0	Pro Loc	Active	No access
0	Pro Loc	Not Active	Immediate access

\*Entering Code 222 allows access regardless of security code.

## USER INPUT ASSIGNMENT

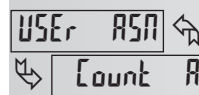

Count A  
Count b  
both A-b

The User Input Assignment is only active if the meter is programmed in the Dual Count Mode and a selection of reset, store, store and reset, or inhibit is selected in the User Input Function menu.

Shaded area selections only apply when programmed for dual count mode.

## 6.2 MODULE 2 - RATE SETUP PARAMETERS (RATE)

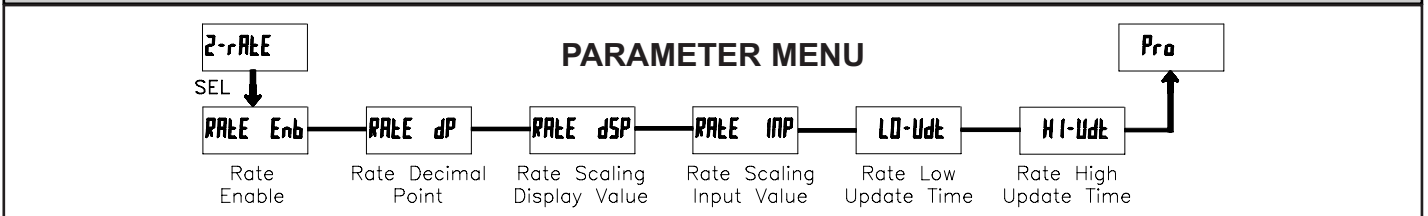

Module 2 is the programming for the Rate parameters. For maximum input frequency, Rate Enable should be set to NO when not in use. When set to YES, the remaining rate parameters are not accessible. The Rate value is shown with an annunciator of "R" in the Display Mode.

### RATE ENABLE

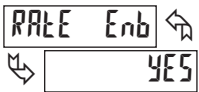

NO YES

### RATE DECIMAL POINT

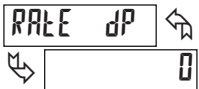

0 00 0000  
00 0000 000000

This selects the decimal point position for rate displays and any setpoint value assigned to these displays. This parameter does not affect rate scaling calculations.

### RATE SCALING DISPLAY VALUE

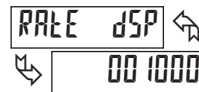

0 to 999999

Enter the desired Rate Display Value for the Scaling Point.\*

### RATE SCALING INPUT VALUE

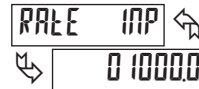

01 to 999999

Enter the corresponding Rate Input Value for the Scaling Point.\*

\*For value entry instructions, refer to selection/value entry in the Programming The Meter section.



## SCALING FOR RATE INDICATION

To scale the Rate, enter a Scaling Display value with a corresponding Scaling Input value. These values are internally plotted to a Display value of 0 and Input value of 0 Hz. A linear relationship is formed between these points to yield a rate display value that corresponds to the incoming input signal rate. The meter is capable of showing a rate display value for any linear process.

## SCALING CALCULATION

If a display value versus input signal (in pulses per second) is known, then those values can be entered into Scaling Display (RATE dSP) and Scaling Input (RATE #PP). No further calculations are needed.

If only the number of pulses per 'single' unit (i.e. # of pulses per foot) is known, then it can be entered as the Scaling Input value and the Scaling Display value will be entered as the following:

RATE PER	DISPLAY (RATE dSP)	INPUT (RATE #PP)
Second	1	# of pulses per unit
Minute	60	# of pulses per unit
Hour	3600	# of pulses per unit

### NOTES:

- If # of pulse per unit is less than 10, then multiply both Input and Display values by 10.
- If # of pulse per unit is less than 1, then multiply both Input and Display values by 100.
- If the Display value is raised or lowered, then Input value must be raised or lowered by the same proportion (i.e. Display value for per hour is entered by a third less (1200) then Input value is a third less of # of pulses per unit). The same is true if the Input value is raised or lowered, then Display value must be raised or lowered by the same proportion.
- Both values must be greater than 0.0.

### EXAMPLE:

- With 15.1 pulses per foot, show feet per minute in tenths. Scaling Display = 60.0 Scaling Input = 15.1.
- With 0.25 pulses per gallon, show whole gallons per hour. (To have greater accuracy, multiply both Input and Display values by 10.) Scaling Display = 36000 Scaling Input = 2.5.

## RATE LOW UPDATE TIME

LO-Udt 0.1 to 999 seconds

0.10

The Low Update Time is the minimum amount of time between display updates for the Rate display. Values of 0.1 and 0.2 seconds will update the display correctly but may cause the display to appear unsteady.

## RATE HIGH UPDATE TIME

HI-Udt 0.2 to 999 seconds

0.20

The High Update Time is the maximum amount of time before the Rate display is forced to zero. (For more explanation, refer to Rate Value Calculation.) The High Update Time **must** be higher than the Low Update Time and higher than the desired slowest readable speed (one divided by pulses per second). The factory setting of 2.0, will force the display to zero for speeds below 0.5 Hz or a pulse every 2 seconds.

## INPUT FREQUENCY CALCULATION

The meter determines the input frequency by summing the number of falling edges received during a sample period of time. The sample period begins on the first falling edge. At this falling edge, the meter starts accumulating time towards Low Update and High Update values. Also, the meter starts accumulating the number of falling edges. When the time reaches the Low Update Time value, the meter looks for one more falling edge to end the sample period. If a falling edge occurs (before the High Update Time value is reached), the Rate display will update to the new value and the next sample period will start on the same edge. If the High Update Time value is reached (without receiving a falling edge after reaching Low Update Time), then the sample period will end but the Rate display will be forced to zero. The High Update Time value must be greater than the Low Update Time value. Both values must be greater than 0.0. The input frequency calculated during the sample period, is then shown as a Rate value determined by the scaling calculation.

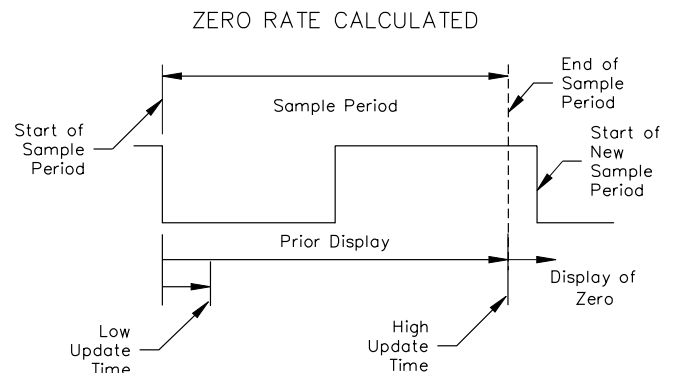
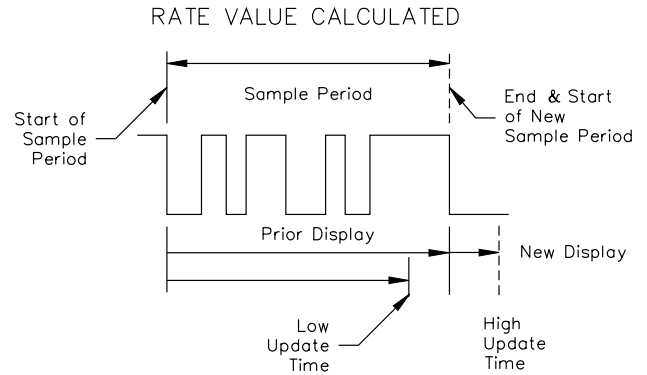

## 6.3 MODULE 3 - DISPLAY AND FRONT PANEL KEY PARAMETERS (3-dSPLAY)

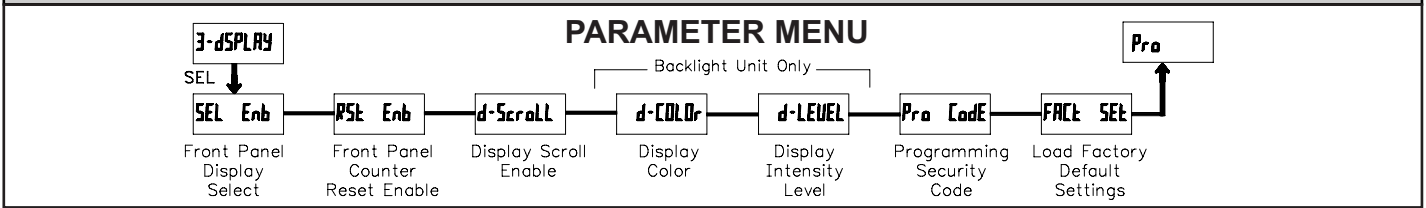

### FRONT PANEL DISPLAY SELECT ENABLE (SEL)

SEL Enb  YES  NO

YES

The YES selection allows the SEL button to toggle through the enabled displays.

### DISPLAY INTENSITY LEVEL (BACKLIGHT UNIT ONLY)

d-LEVEL  1 to 5

5

Enter the desired Display Intensity Level (1-5). The display will actively dim or brighten as levels are changed. This parameter is active for backlight units only.

### FRONT PANEL COUNTER RESET ENABLE (RST)

RSt Enb  YES  NO both A-b

YES

Count A dSPLAY

Count b

The YES selection allows the RST button to reset the selected counter(s). The shaded selections are only active when the meter is programmed for Dual Count Mode.

### PROGRAMMING SECURITY CODE

Pro Code  0 to 999

000

Programming a value other than 000, requires the security code to be entered before any programming changes can be made. This parameter can be used in conjunction with the Program Mode Lock-out in the Input Setup Parameters section.

### DISPLAY SCROLL ENABLE

d-ScroLL  YES  NO

NO

The YES selection allows the display to automatically scroll through the enabled displays. The scroll rate is about every 4 seconds.

### DISPLAY COLOR (BACKLIGHT UNIT ONLY)

d-COLOR  rEd  Grn

rEd

Enter the desired display color, red or green. This parameter is active for backlight units only.

### LOAD FACTORY DEFAULT SETTINGS

FACT SET  NO  YES

NO

The YES selection will return the meter to the factory default settings. The meter will display rSEt and then return to Pro, at which time all settings have been changed.

Pressing the RST key on power-up will load the factory settings and display rSEt. This allows operation in the event of a memory failure or corrupted data.

## 6.4 MODULE 4 - SETPOINT OUTPUT PARAMETERS (4-SEtPt)

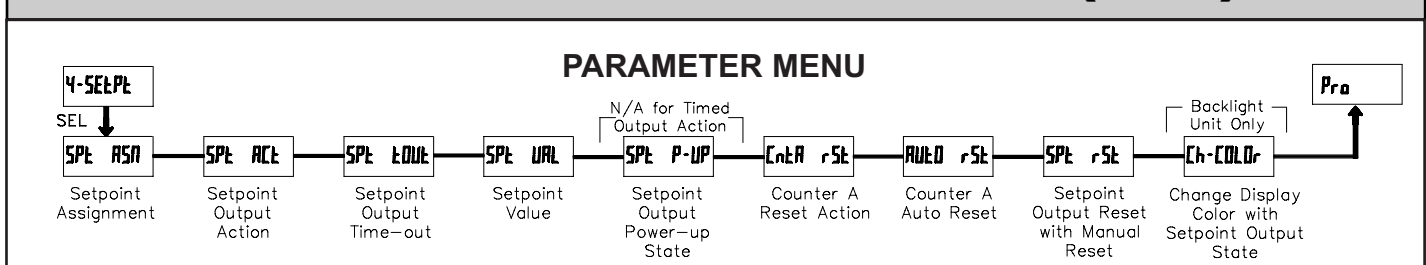

The Setpoint Output Parameters are only active when the optional relay module is installed in the meter. Some parameters will not appear depending on the Setpoint Assignment and Setpoint Output Action selected.

### SETPOINT ASSIGNMENT

SPt ASN  Count A  rSEt

Count A

Select the display the Setpoint is to be assigned.

### SETPOINT OUTPUT ACTION

SPt ACT  LAtCH  t-OUT  bOUNd

LAtCH

This parameter selects the action of the Setpoint output.

## SETPOINT OUTPUT ACTIONS

SPT ACTION	DESCRIPTION	OUTPUT ACTIVATES	OUTPUT DEACTIVATES
LATCH	Latched Output Mode	When Count = Setpoint	At Manual Reset (if SPT rSt=YES)
t-OUT	Timed Output Mode	When Count = Setpoint	After Setpoint Output Time-Out
BOUND	Boundary Mode	When Count ≥ Setpoint	When Count < Setpoint

### SETPOINT OUTPUT TIME-OUT

SPT tOUT ↵  
 ↵ 0 100 001 to 9999 seconds

This parameter is only active if the Setpoint Action is set to time out (t-OUT). Enter the value in seconds that the Setpoint will be active, once the Setpoint Value is reached.

### SETPOINT VALUE

SPT VAL ↵  
 ↵ 00000 100 Count A: -9999999 to 9999999  
 Rate: 0 to 999999

Enter the desired Setpoint value. To enter a negative setpoint value, increment digit 8 to display a "-" sign.

### SETPOINT OUTPUT POWER-UP STATE

SPT P-UP ↵  
 ↵ OFF OFF OFF  
 ON SAVE

SAVE will restore the output to the same state it was at before the meter was powered down. ON will activate the output at power up. OFF will deactivate the output at power up. This parameter is not active when the Setpoint Action is selected for timed output mode.

## COUNTER A RESET ACTION

CntA rSt ↵  
 ↵ to ZEr0 to SPT

When Counter A is reset, it returns to zero or the Setpoint Value. When the Reset Action is selected for to SPT (Reset to Setpoint), the output activates at zero. Boundary Mode is only active when Programmed for to ZEr0 (Reset to Zero).

### COUNTER A AUTO RESET

AUTO rSt ↵  
 ↵ NO NO  
 Out-Start Out-End

This automatically resets the display value of Counter A each time the Setpoint Value is reached. The automatic reset occurs at output start or end. The Out-End is only active when setpoint output action is selected for t-OUT.

### SETPOINT OUTPUT RESET WITH MANUAL RESET

SPT rSt ↵  
 ↵ YES YES NO

Select YES, so the Setpoint output will deactivate (reset) when a manual reset is applied to the meter. Manual reset can occur by the RST button or the User Input, if programmed for that function. When the Setpoint Assignment, (SPT ASS) is set to Count A, this parameter only applies to Count A reset.

### CHANGE DISPLAY COLOR w/SETPOINT OUTPUT STATE

Ch-COLOR ↵  
 ↵ NO NO YES

This parameter enables the backlight CUB5 to switch the backlight color when the Setpoint Value is reached. A reset will revert the backlight color to the normal operating mode color. This parameter is only active for the backlight version.

## LIMITED WARRANTY

The Company warrants the products it manufactures against defects in materials and workmanship for a period limited to one year from the date of shipment, provided the products have been stored, handled, installed, and used under proper conditions. The Company's liability under this limited warranty shall extend only to the repair or replacement of a defective product, at The Company's option. The Company disclaims all liability for any affirmation, promise or representation with respect to the products.

The customer agrees to hold Red Lion Controls harmless from, defend, and indemnify RLC against damages, claims, and expenses arising out of subsequent sales of RLC products or products containing components manufactured by RLC and based upon personal injuries, deaths, property damage, lost profits, and other matters which Buyer, its employees, or sub-contractors are or may be to any extent liable, including without limitation penalties imposed by the Consumer Product Safety Act (P.L. 92-573) and liability imposed upon any person pursuant to the Magnuson-Moss Warranty Act (P.L. 93-637), as now in effect or as amended hereafter.

No warranties expressed or implied are created with respect to The Company's products except those expressly contained herein. The Customer acknowledges the disclaimers and limitations contained herein and relies on no other warranties or affirmations.

