

DITAK 8 - ADJUSTABLE TIMEBASE 5-DIGIT RATE INDICATOR

- LCD, POSITIVE REFLECTIVE OR NEGATIVE TRANSMISSIVE WITH YELLOW/GREEN OR RED BACKLIGHTING
- 0.6 INCH (15.2 mm) HIGH DIGITS
- ADJUSTABLE TIMEBASE FROM 4 MSEC TO 32 SEC
- INTERNAL LITHIUM BATTERY PROVIDES OVER 7 YEARS OF CONTINUOUS OPERATION
- NEMA 4X/IP65 SEALED FRONT PANEL BEZEL
- ACCEPTS MAGNETIC OR LOGIC TYPE SIGNAL INPUTS
- WIRE CONNECTIONS MADE VIA SCREW CLAMP TYPE TERMINALS



DESCRIPTION

The Ditak 8 is a self-powered rate indicator which features selectable Timebase Increments by setting the appropriate DIP switches on the rear of the unit. The internal 3.0 VDC lithium battery will operate continuously for at least 7 years. It has a 5-digit LCD display with 0.6 inch (15.2 mm) high digits. The displays are available in positive image reflective (black digits, reflective background) or negative image transmissive (illuminated digits, dark background) with red or yellow/green backlighting. Backlight version units require power from an external 9 to 28 VDC supply.

The unit is constructed of a lightweight, high impact plastic case with a clear viewing window. The sealed front panel meets NEMA 4X/IP65 specifications for wash-down and/or dusty environments, when properly installed.

The optional Micro Line/Sensor Power Supply (MLPS1000) is designed to attach to the rear of an installed Ditak 8. The optional supply can be powered from 85 to 250 VAC, and can provide power for the backlighting of a unit and most sensors.

SAFETY SUMMARY

All safety related regulations, local codes and instructions that appear in the manual or on equipment must be observed to ensure personal safety and to prevent damage to either the instrument or equipment connected to it. If equipment is used in a manner not specified by the manufacturer, the protection provided by the equipment may be impaired.

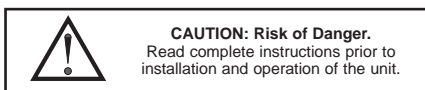

SPECIFICATIONS

- DISPLAY:** 5-Digit LCD, 0.6" (15.2 mm) high digits.
- POWER SOURCE:** Internal 3.0 V lithium battery provides over 7 years of continuous service (battery life is dependent upon usage).
- BACKLIGHT POWER REQUIREMENTS:** 9 to 28 VDC @ 35 mA. Above 26 VDC, derate operating temperature to 50 °C. Must use the MLPS1 or a Class 2 or SELV rated power supply.
- SIGNAL INPUT:** 0 to 10 KHz from a magnetic or bi-polar output (with a 50% duty cycle). Min. input sensitivity is 0.9 V. Max. input = 28 VDC.
- TIMEBASE:** Adjustable in 1/256 sec (3.906 msec) increments via DIP switches located at the rear of the unit. Timebase ranges from 3.906 msec to 31.998 sec; 0.01% ±1 digit accuracy.
- ENVIRONMENTAL CONDITIONS:**
 - Operating Temperature:** 0 to 60 °C (Above 50 °C derate backlight operating voltage to 26 VDC max.)
 - Storage Temperature:** -40 to 80 °C
 - Operating and Storage Humidity:** 85% max. (non-condensing) from 0 °C to 60 °C.
 - Vibration According to IEC 68-2-6:** Operational 5 to 500 Hz, in X, Y, Z direction for 1.5 hours, 5 g's.
 - Shock According to IEC 68-2-27:** Operational 30 g's, 11 msec in 3 directions.
 - Altitude:** Up to 2000 meters
- CONSTRUCTION:** High impact plastic case with clear viewing window (Panel gasket and mounting clip included). Installation Category I, Pollution Degree 2.

ORDERING INFORMATION

MODEL NO.	DESCRIPTION	PART NUMBER
DT8	Adjustable Timebase Tachometer	DT800000
	Adjustable Timebase Tachometer with Yellow/Green Backlighting	DT800010
	Adjustable Timebase Tachometer with Red Backlighting	DT800020
MLPS	Micro Line Sensor/Power Supply	MLPS1000

DIMENSIONS In inches (mm)

Note: Recommended minimum clearance (behind the panel) for mounting clip installation is 2.15" (54.6) H x 3.00" (76.2) W.

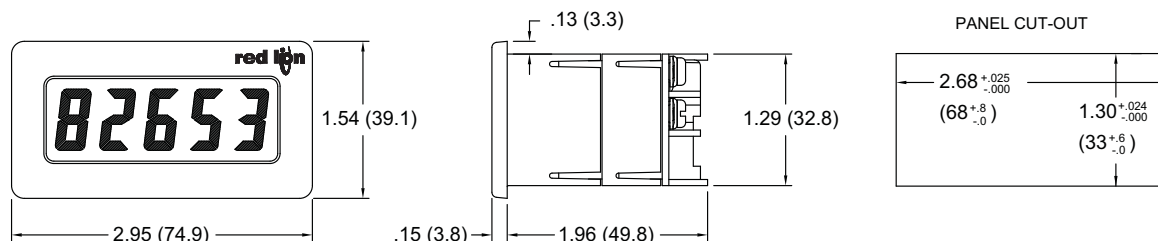

SPECIFICATIONS (Cont'd)

8. CERTIFICATIONS AND COMPLIANCES:

SAFETY

IEC 1010-1, EN 61010-1: Safety requirements for electrical equipment for measurement, control, and laboratory use, Part 1.

IP65 Enclosure rating (Face only), IEC 529
 Type 4X Enclosure rating (Face only), UL50

ELECTROMAGNETIC COMPATIBILITY

Emissions and Immunity to EN 61326

Immunity:

Electrostatic discharge	EN 61000-4-2	Criterion B 4 kV contact discharge 8 kV air discharge
Electromagnetic RF fields	EN 61000-4-3	Criterion A 10 V/m
Fast transients (burst)	EN 61000-4-4	Criterion B 2 kV power 2 kV signal
Surge	EN 61000-4-5	Criterion A 1 kV L-L, 2 kV L&N-E power 1 kV signal
RF conducted interference	EN 61000-4-6	Criterion A 3 V/rms
Voltage dip/interruptions	EN 61000-4-11	Criterion A 0.5 cycle

Emissions:

Emissions	EN 55011	Class B
-----------	----------	---------

Notes:

1. Criterion A: Normal operation within specified limits.
2. Criterion B: Temporary loss of performance from which the unit self-recovers.

Refer to the EMC Installation Guidelines section of this bulletin for additional information.

9. WEIGHT: 3.4 oz (96.4 g)

EMC INSTALLATION GUIDELINES

Although this unit is designed with a high degree of immunity to ElectroMagnetic Interference (EMI), proper installation and wiring methods must be followed to ensure compatibility in each application. The type of the electrical noise, source or coupling method into the unit may be different for various installations. In extremely high EMI environments, additional measures may be needed. Cable length, routing and shield termination are very important and can mean the difference between a successful or a troublesome installation. Listed below are some EMC guidelines for successful installation in an industrial environment.

1. Use shielded (screened) cables for all Signal and Control inputs. The shield (screen) pigtail connection should be made as short as possible. The connection point for the shield depends somewhat upon the application. Listed below are the recommended methods of connecting the shield, in order of their effectiveness.
 - a. Connect the shield only at the panel where the unit is mounted to earth ground (protective earth).
 - b. Connect the shield to earth ground at both ends of the cable, usually when the noise source frequency is above 1 MHz.
 - c. Connect the shield to common of the unit and leave the other end of the shield unconnected and insulated from earth ground.
2. Never run Signal or Control cables in the same conduit or raceway with AC power lines, conductors feeding motors, solenoids, SCR controls, and heaters, etc. The cables should be run in metal conduit that is properly grounded. This is especially useful in applications where cable runs are long and portable two-way radios are used in close proximity or if the installation is near a commercial radio transmitter.
3. Signal or Control cables within an enclosure should be routed as far away as possible from contactors, control relays, transformers, and other noisy components.
4. In extremely high EMI environments, the use of external EMI suppression devices, such as ferrite suppression cores, is effective. Install them on Signal and Control cables as close to the unit as possible. Loop the cable through the core several times or use multiple cores on each cable for additional protection. Install line filters on the power input cable to the unit to suppress power line interference. Install them near the power entry point of the enclosure. The following EMI suppression devices (or equivalent) are recommended:

Ferrite Suppression Cores for signal and control cables:

Fair-Rite # 0443167251 (RLC #FCOR0000)

TDK # ZCAT3035-1330A

Steward #28B2029-0A0

Line Filters for input power cables:

Schaffner # FN610-1/07 (RLC #LFIL0000)

Schaffner # FN670-1.8/07

Corcom #1VR3

Note: Reference manufacturer's instructions when installing a line filter.

5. Long cable runs are more susceptible to EMI pickup than short cable runs. Therefore, keep cable runs as short as possible.

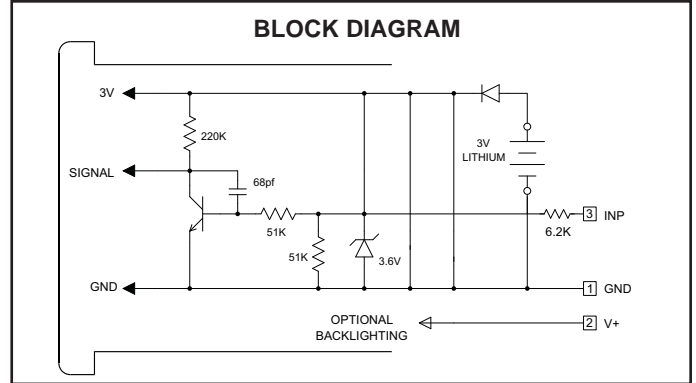

WIRING CONNECTIONS

The electrical connections are made via rear screw-clamp terminals located on the back of the unit. All conductors should meet voltage and current ratings for each terminal. Also cabling should conform to appropriate standards of good installation, local codes and regulations. It is recommended that power supplied to the unit (AC or DC) be protected by a fuse or circuit breaker. When wiring the unit, use the label to identify the wire position with the proper function. Strip the wire, leaving approximately 1/4" bare wire exposed (stranded wires should be tinned with solder). Insert the wire into the screw-clamp terminal and tighten the screw until the wire is clamped tightly. Each terminal can accept up to two #14 AWG wires.

The backlighting for a backlight version unit is powered between Terminal 2 (V+) and Terminal 1 (GND).

Variable Frequency AC Inputs, Signal Source Powered

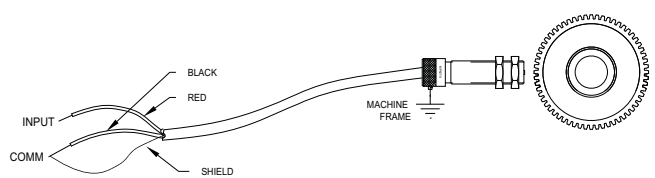

Variable Frequency AC Inputs, Signal Source Powered

Minimum V_{AC} for operation is 0.9 V peak.

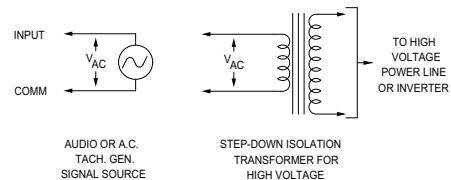

Logic Pulse Inputs From Other Circuits & Sensors

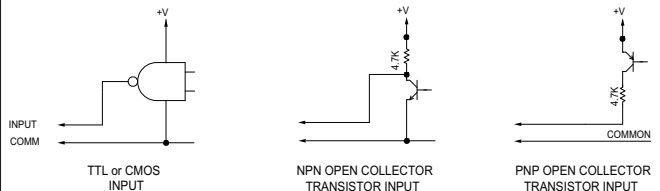

REAR PANEL DIP SWITCHES

When viewing the Ditak 8 from the rear, there are two banks of DIP switches located along the top edge of the PC board. The bank of eight switches to the left is labeled SWA and the bank of six switches to the right is labeled SWB. All of the SWA switches and five of the SWB switches are used to select the desired Timebase. The remaining switch of SWB is used to select Frequency Doubling.

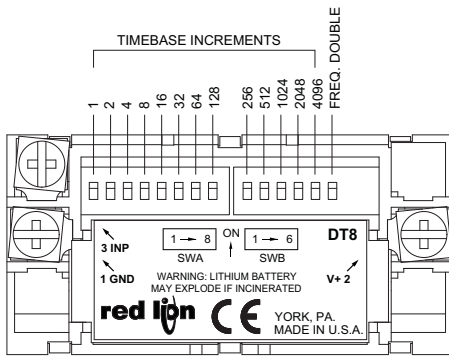

WARNING: Lithium battery may explode if incinerated.

FREQUENCY DOUBLING

DIP switch SWB 6 is the "Frequency Doubling" switch. When it is in the "ON" position, frequency doubling is disabled. When set to the "OFF" position, it is enabled and twice the number of input pulses are registered in the unit. This doubling of the input rate allows the Timebase Increment Total to be halved, thus allowing a faster update time for a given display value.

TIMEBASE SELECTION

The Ditak 8 has a Timebase selection range from 3.906 msec to 31.998 sec. SWA 1 is set to the "ON" position for the minimum Timebase setting. SWA 1 through SWB 5 are set to the "ON" position for the maximum Timebase setting. A specific Timebase setting is achieved by adding the appropriate individual Timebase increments.

SWITCH	TIMEBASE INCREMENTS	SWITCH	TIMEBASE INCREMENTS
SWA 1	1	SWB 1	256
SWA 2	2	SWB 2	512
SWA 3	4	SWB 3	1024
SWA 4	8	SWB 4	2048
SWA 5	16	SWB 5	4096
SWA 6	32	SWB 6	FREQ. DBL.
SWA 7	64		
SWA 8	128		

The Timebase increment total is computed according to the following formula:

$$\text{TIMEBASE INCREMENT TOTAL (TBIT)} = \frac{\text{DR} \times 15,361}{\text{RPM} \times \text{PPR} \times \text{FQ.DBL.}}$$

WHERE:

DR	=	Desired Reading
RPM	=	Revolutions Per Minute
PPR	=	Pulses Per Revolution
FQ.DBL.	=	Frequency Doubling disable (times 1 switch on, times 2 switch off)

Example: Find the appropriate Timebase DIP switch setting for desired parameters.

Desired Readout (DR)	=	2500
Revolutions Per Minute (RPM)	=	1250
Pulses Per Revolution (PPR)	=	50
FQ.DBL.	=	ON (times 1 switch on)

$$\text{TIMEBASE INCREMENT TOTAL (TBIT)} = \frac{2500 \times 15,361}{1250 \times 50 \times 1}$$

$$\text{TBIT} = 614.44$$

$$\text{TBIT} = 614 \text{ \{round to the nearest whole number\}}$$

$$\text{TBIT} = 614$$

DIP SWB 2	-	<u>512</u>	
		102	- Needed
DIP SWA 7	-	<u>64</u>	
		38	- Needed
DIP SWA 6	-	<u>32</u>	
		6	- Needed
DIP SWA 3	-	<u>4</u>	
		2	- Needed
DIP SWA 2	-	<u>2</u>	
		0	- Needed

Note: If no timebase switches are turned on, the Ditak 8 will default to 3.906 msec timebase.

DIP switches SWA 2, 3, 6, 7, and SWB 2 are all set to the "ON" position for a Timebase Increment Total of 614. If it is desired to know what the approximate Timebase is in seconds, use the following formula:

$$\begin{aligned} \text{TBIT} \times 0.003906 &= \text{Time in seconds} \\ 614 \times 0.003906 &= 2.398 \text{ sec.} \end{aligned}$$

TYPICAL APPLICATION

CONVEYOR BELT SPEED INDICATOR

It is desired to display the rate of a conveyor belt used to carry PC Boards through an infrared soldering chamber that is variable from 0 to 10 feet per minute. The rate must be adjusted depending on the size of the boards being soldered. The display of the rate indicator must read in feet per minute. The shaft of the variable speed motor contains a keyway. A speed of 100 RPM will produce a belt speed of 10 ft/min. A proximity sensor is used to monitor the speed of the shaft. The Ditak 8 can be used to display the belt speed in this application. The output signal of the sensor is connected to the Ditak 8 Terminal 3 (INP). The sensor common and shield are connected to the Ditak 8 Terminal 1 (GND). The Timebase setting is to be determined by using the formula.

$$\text{TIMEBASE INCREMENT TOTAL (TBIT)} =$$

$$\frac{\text{DR} \times 15,361}{\text{RPM} \times \text{PPR} \times \text{FQ.DBL.}} = \frac{10 \times 15,361}{100 \times 1 \times 1}$$

Desired Reading	=	10
MAX RPM Of Shaft	=	100
Pulses Per Revolution	=	1
FQ.DBL.	=	ON (times 1 switch on)

$$\text{TBIT} = 1536.1$$

$$\text{TBIT} = 1536 \text{ \{round to the nearest whole number\}}$$

$$\text{TBIT} = 1536$$

DIP SWB 3	-	<u>1024</u>	
		512	- Needed
DIP SWB 2	-	<u>512</u>	
		0	- Needed

With these DIP switch settings, the Timebase would be approximately 5.99 sec (1536 x 0.003906 = 5.995). To reduce the display update time, the "Frequency Doubling" switch can be enabled (set to the "OFF" position). Therefore, only half the Timebase will be necessary (768 x 0.003906 = 2.99 sec.).

$$\text{TBIT} = 768$$

DIP SWB 2	-	<u>512</u>	
		256	- Needed
DIP SWB 1	-	<u>256</u>	
		0	- Needed
DIP SWB 6	-	OFF	- Frequency Doubling Enabled

INSTALLATION ENVIRONMENT

The unit should be installed in a location that does not exceed the maximum operating temperature and provides good air circulation. Placing the unit near devices that generate excessive heat should be avoided.

The bezel should be cleaned only with a soft cloth and neutral soap product. Do NOT use solvents.

Continuous exposure to direct sunlight may accelerate the aging process of the bezel.

INSTALLATION

The Ditak 8 meets NEMA 4X/IP65 requirements for indoor use, when properly installed. The units are intended to be mounted into an enclosed panel. A sponge rubber gasket, mounting clip, two screws, and nut fasteners are provided to install and seal the unit in the panel cut-out.

The following procedure assures proper installation:

1. Cut panel opening to specified dimensions. Remove burrs and clean panel opening.
2. Slide the panel gasket over the rear of the unit to the back of the bezel.
3. Slide nut fastener into slot on mounting clip and then insert mounting screw through nut on both sides of mounting clip. Tip of mounting screw should NOT project through hole on clip.
4. Install Ditak unit through panel cut-out.
5. Slide mounting clip over rear of unit until clip is against back of panel. The mounting clip and Ditak housing have a latching feature to hold the unit in place until tightened.

Note: Hold the Ditak front bezel in place when sliding the mounting clip into position.

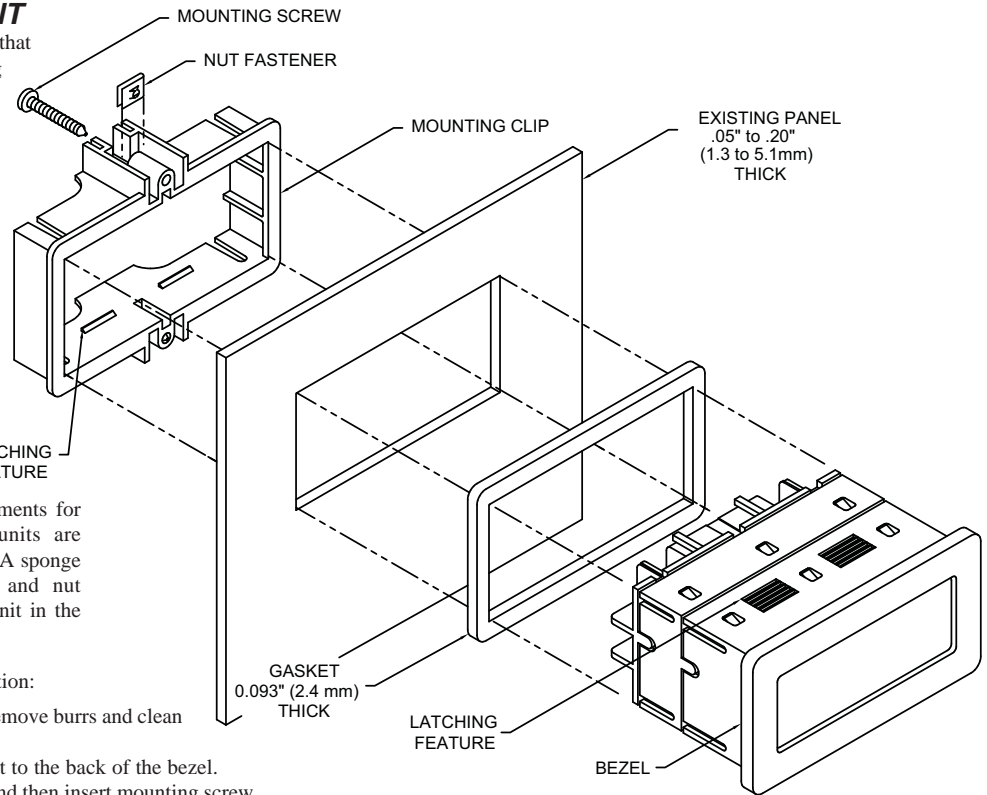

6. Alternately tighten each mounting screw to ensure uniform gasket pressure. Visually inspect the gasket for proper seal. The gasket should be compressed approximately 75 to 80% of its original thickness.
7. If the gasket is not adequately compressed and the mounting screws cannot be tightened any further, loosen mounting screws and insure that the clip is latched as close as possible to the panel.
8. Repeat step #6 for tightening the mounting screws.

TROUBLESHOOTING

For further technical assistance, contact technical support at the appropriate company numbers listed.

LIMITED WARRANTY

The Company warrants the products it manufactures against defects in materials and workmanship for a period limited to two years from the date of shipment, provided the products have been stored, handled, installed, and used under proper conditions. The Company's liability under this limited warranty shall extend only to the repair or replacement of a defective product, at The Company's option. The Company disclaims all liability for any affirmation, promise or representation with respect to the products.

The customer agrees to hold Red Lion Controls harmless from, defend, and indemnify RLC against damages, claims, and expenses arising out of subsequent sales of RLC products or products containing components manufactured by RLC and based upon personal injuries, deaths, property damage, lost profits, and other matters which Buyer, its employees, or sub-contractors are or may be to any extent liable, including without limitation penalties imposed by the Consumer Product Safety Act (P.L. 92-573) and liability imposed upon any person pursuant to the Magnuson-Moss Warranty Act (P.L. 93-637), as now in effect or as amended hereafter.

No warranties expressed or implied are created with respect to The Company's products except those expressly contained herein. The Customer acknowledges the disclaimers and limitations contained herein and relies on no other warranties or affirmations.

Red Lion Controls
Headquarters
20 Willow Springs Circle
York PA 17406
Tel +1 (717) 767-6511
Fax +1 (717) 764-0839

Red Lion Controls
Europe
Printerweg 10
NL - 3821 AD Amersfoort
Tel +31 (0) 334 723 225
Fax +31 (0) 334 893 793

Red Lion Controls
India
54, Vishvas Tenement
GST Road, New Ranip,
Ahmedabad-382480 Gujarat, India
Tel +91 987 954 0503
Fax +91 79 275 31 350

Red Lion Controls
China
Unit 101, XinAn Plaza
Building 13, No.99 Tianzhou Road
ShangHai, P.R. China 200223
Tel +86 21 6113-3688
Fax +86 21 6113-3683