

# Instruction **Manual**

## Series J5 12 VDC Metering Pump

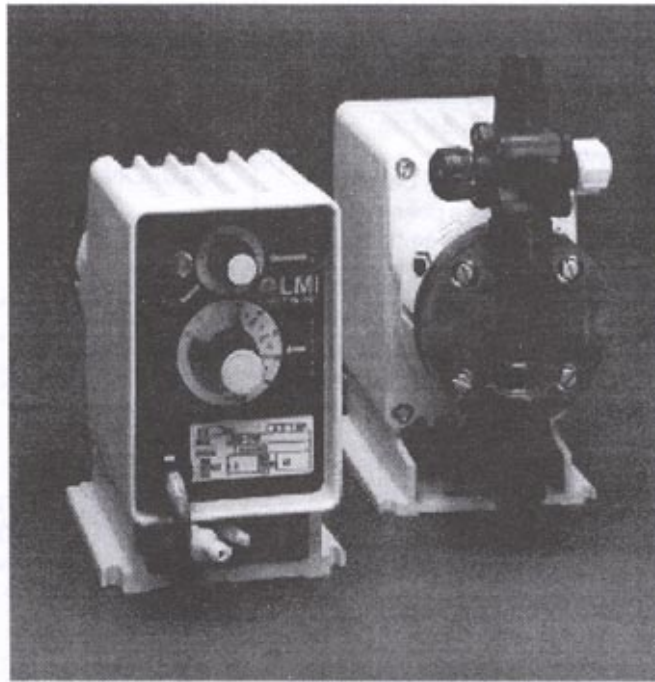

For file reference, please record the following data:

Model No: \_\_\_\_\_

Serial No: \_\_\_\_\_

Installation Date: \_\_\_\_\_

Installation Location: \_\_\_\_\_

When ordering replacement parts for your LMI Controller or accessory, please include the complete Model Number and Serial Number of your unit.



8 Post Office Square  
Acton, MA 01720 USA  
TEL: (508) 263-9800  
FAX: (508) 264-9172  
<http://www.lmipumps.com>



Replaces same of Rev.C 10/94  
1584.D 3/97

# INSTALLATION

## I. UNPACKING

A. Remove tubing, injection check and foot valve from the pump carton. Notify delivery carrier immediately if there are any signs of damage to the metering pump or parts.

## II. LOCATION AND MOUNTING

### CAUTION

*When pumping solutions make certain that all tubing is securely attached to the fittings. It is recommended that tubing or pipe lines be shielded to prevent possible injury in case of rupture or accidental damage. Always wear protective face shield and clothing when working on or near a solution metering pump.*

A. Locate the pump in an area that is convenient to both solution injection point and 12 VDC battery. Your pump may also be solar powered using a 24" x 21" (61 cm x 54 cm) module combination with solar battery charger.

The pump running at maximum frequency (speed) will discharge a battery at an average rate of 1.6 amps, for a power consumption of 19 watts. A peak current draw of 8.3 amps occurs during each pump pulse. A battery with a 70 amp-hour capacity will operate the pump for approximately 22 hours when it will be discharge approximately 50%.

To calculate the running time, follow this example:

$$\frac{70 \text{ amp-hour}}{1.6 \text{ Amps}} \times 50\% = 22 \text{ hours}$$

The temperature and the condition of the battery will affect actual capacity of the battery. Power consumption of the LMI Metering Pump is proportional to the stroke frequency. LMI solution metering pumps have corrosion resistant housings, but should not be subjected to continuous high temperature (over 110°F or 43°C), and should be shielded from direct weather exposure.

B. Mount pump on recess of a small solution tank. LMI Model No. 27421 Ten Gallon Tank is most suitable for this purpose (see illustration below).



C. Pump may also be mounted on top of molded solution tank cover provided the cover has a recess for pump mounting to prevent pump from sliding. A molded recess for this purpose is included with LMI tank and cover assemblies, in 35 and 50 gallon size.

D. Diagrams (below and on the following page) show typical solution pump installation methods. Note location of injection check valve which is most important. Refer to separate **Liquid Handling Assembly Instructions** regarding installation of injection check valve.

### CAUTION

*Be sure installation does not constitute a cross connection. Check local plumbing code.*

## FLOODED SUCTION INSTALLATION

*Helpful when pumping at very low rate*

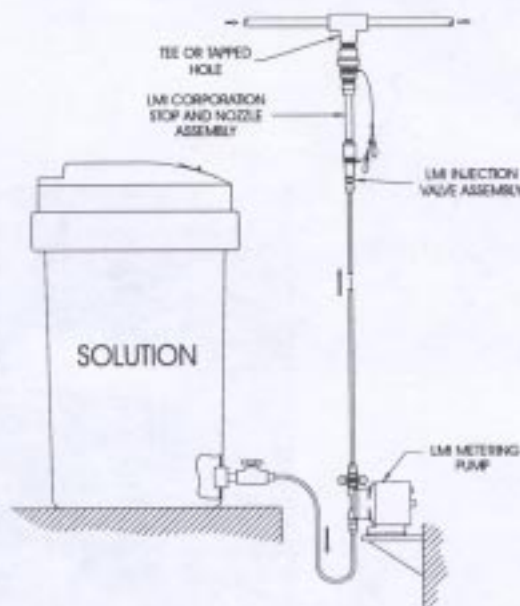

## AVOID THIS TYPE OF 'FALSE' FLOODED SUCTION INSTALLATION

*The loop at the top of the tank forms a neat air trap. In time, air and gasses can bubble out, accumulate, and cause loss of prime.*

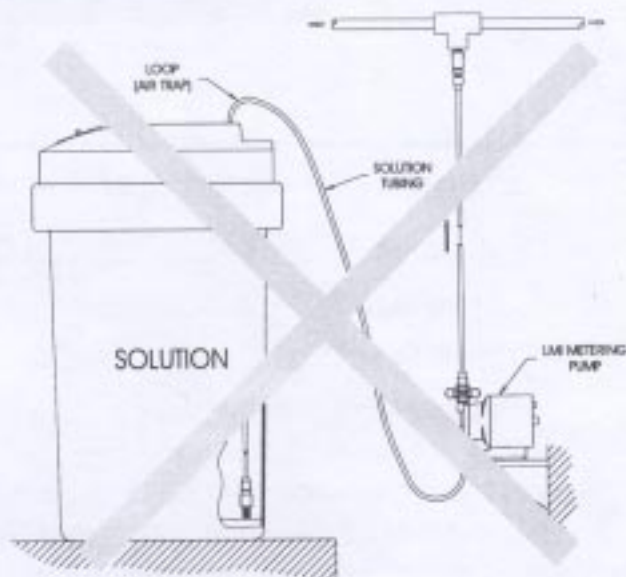

E. Back Pressure Requirements - All electronically controlled magnetically driven pumps maintain maximum velocity on the discharge portion of their stroke regardless of the

speed setting. If there is little or no resistance (back pressure), the velocity of the pumped fluid will cause over-pumping. Because of this characteristic, back pressure equal to approximately 25 psi must be supplied by an anti-syphon/back pressure valve if the system pressure at the injection point is not high enough to provide the needed back pressure.

#### PREVENT SYPHONING WHEN PUMPING

*downhill or into pump suction. Always use anti-syphon/back pressure valve at pump discharge (a) or at injection point (c).*

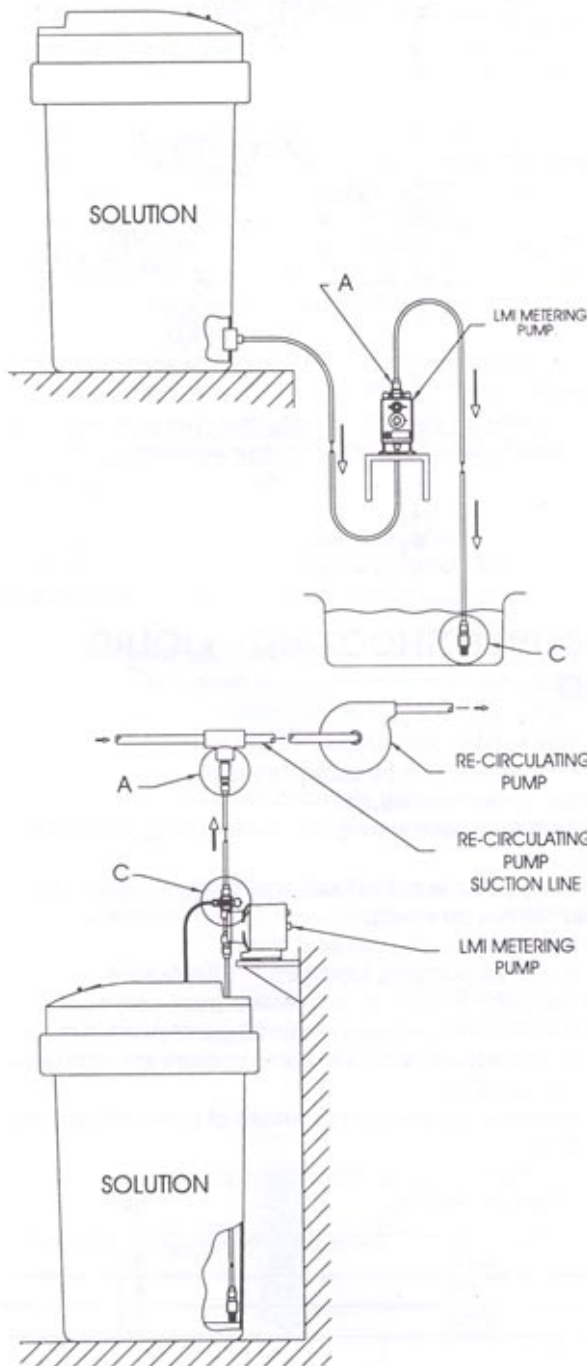

### III. ELECTRICAL

A. Solution metering pump should be connected to a 12 VDC battery. The pump running at maximum frequency (speed) will discharge a battery at an average rate of 1.6 amps, for a power consumption of 19 watts. A peak current draw of 8.3 amps occurs during each pump pulse. A battery with a 70 amp-hour capacity will operate the pump for approximately 22 hours when it will be discharge approximately 50%.

The temperature and the condition of the battery will affect actual capacity of the battery. Power consumption of the LMI Metering Pump is proportional to the stroke frequency. Be sure the speed adjustment knob is in the "EXT" position and that external connector leads are disconnected from any external trigger device.

B. Note proper polarity. Although pump is reverse polarity protected, it will not operate if polarity is incorrect.

#### WIRING DIAGRAM PRESSURE OR FLOW SWITCH SYSTEM

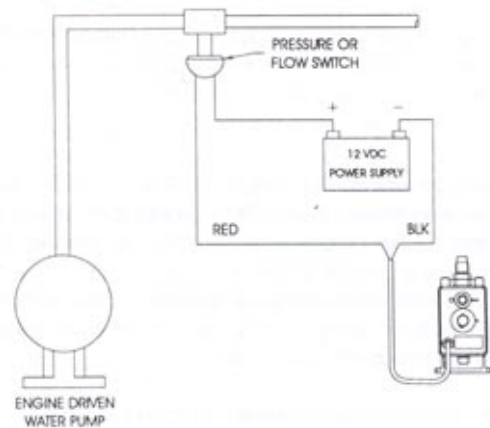

### OUTPUT ADJUSTMENT

#### I. INITIAL APPROXIMATION

A. Speed adjustment knob is the uppermost of the two knobs on the control panel. Speed dial is graduated in approximate strokes per minute. Turning this knob clockwise  increases pumping frequency. **For minimum power consumption, minimize speed and maximize stroke length.**



Output Estimate - Total output of pump may be estimated by multiplying speed (percent of maximum) by stroke length setting (percent of maximum).

For example, if the stroke length knob is set at 100% of maximum and the speed is 20% of maximum, total pump output will be approximately 20%; if the stroke length knob is set at 30% of maximum and speed is 20% of maximum, total output of pump will be approximately 6% of the pump's maximum rating. That is, 20% times 30% equals 6%.

B. To determine exact frequency in strokes per minute at any speed knob setting, count number of flashes of speed pilot light for one minute.

C. Stroke length adjustment knob is lower of two control panel knobs. Adjust by rotating to desired setting, while pump is stroking.

**II. SETTING** (See diagram below)

- A. Maximum output - Turn Speed Knob clockwise  to a setting of 100 on its dial.  
Turn Stroke Length Knob clockwise  to a setting of 100 on its dial.
- B. Reduced output - Turn Speed Knob counter-clockwise  to a setting representing the desired percentage of the pump's total output capability.

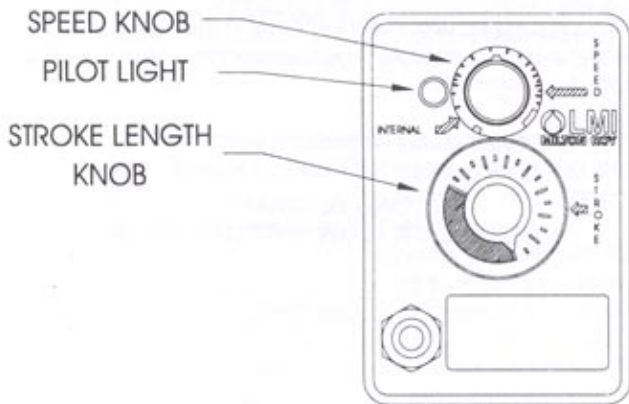

For maximum volumetric efficiency leave Stroke Length Knob at its maximum setting (100) unless it is impossible to reduce the pump's output sufficiently by turning Speed Knob. If Stroke Length Knob must be adjusted in order to reduce pump output, avoid turning it below minimum setting indicated on dial: doing so reduces the length of the stroke causing volumetric efficiency loss.

- C. After installation is complete and an initial approximation setting has been made, the pump should be calibrated and the speed and/or stroke length settings adjusted.

**III. CALIBRATION PROCEDURE - ON-SITE VOLUMETRIC CALIBRATION**

- A. With pump primed and discharge tubing connected to the injection point as it would be in normal service, place foot valve and strainer assembly in a graduated container with a volume of 500 ml or more (so that the volume displaced by tubing and foot valve assembly is minimal in relation to volume of solution in the container).
- B. Switch pump on, and pump until air is exhausted from the suction line and pump head.
- C. Switch pump off, note the solution level in the graduate. Refill graduate if necessary.
- D. Switch pump on, and permit it to pump for a measured time. Be sure time is long enough to accumulate an adequate number (minimum 50) pump strokes. In general, the longer the calibration period, the more confidence you can have in accuracy of results.
- E. Switch off pump at the end of the calibration period, note volume pumped during the calibration period, and calculate volume of solution pumped in time unit you choose (minute, hour, day, etc.).

- F. Adjust speed and/or stroke length knobs to your best estimate of required correction, and repeat calibration measurement as a check.

This calibration adjustment should always be made with pumping conditions identical to conditions of normal pumping service. This means that factors such as injection pressure, fluid viscosity, suction lift and others will automatically be accounted for in making final adjustment of the pump.

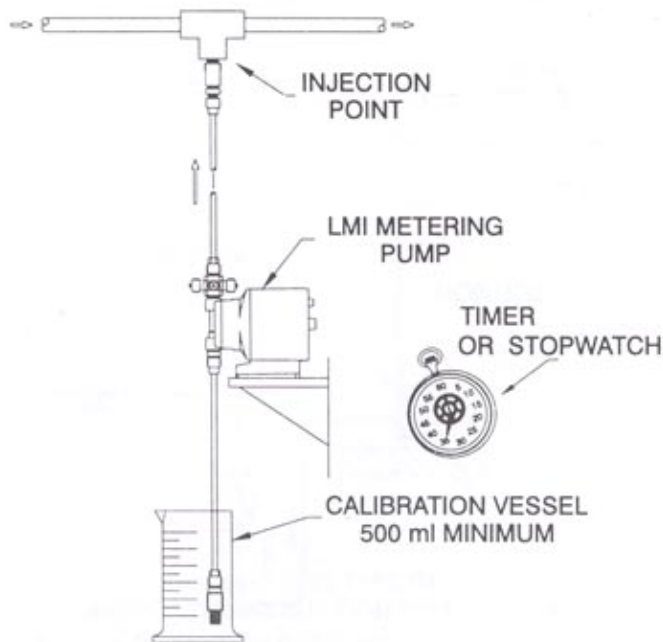

**TROUBLE SHOOTING - LIQUID END**

**I. LOW PUMP OUTPUT**

Low pump output can be caused by many things. Some of the more common ones are:

- Very low stroke setting, i.e. red (or black) zone setting of knob.
- Trapped air in pump head (trapped air in discharge tubing has no effect).
- Air leak through valve seal rings.
- Ruptured pumping Liquifram™ (diaphragm).
- Clogged Liquid End, or injection point connection.
- Injection into pressure within 25 psi of pump's maximum pressure rating with back pressure spring in place (if so supplied).
- Injection into pressure in excess of pump rating - see chart.

Pressure Ratings:	PSI	bar
J54D	140	9.7
J55D	60	4.1
J56D	20	1.4

- A. Very low stroke setting - check position of stroke length knob (lower knob) by rotating it counter-clockwise 

until pumping diaphragm (Liquifram™) stops moving with the pump operating. The pumping diaphragm should not stop reciprocating (moving or clicking) until the knob points to zero. If it stops before zero, reset knob to point to zero and tighten collet nut.

Rotate knob clockwise  and operate pump with stroke length setting above the dial's red (or black) zone.

B. Trapped air in pump head - May be caused by leaks in the suction line, where the suction line joins the suction fitting, or at the seal ring between suction fitting and pump head. It may also be caused by air or gases coming out of the solution. Trapped air or bubbles in the discharge line have no effect on the pump's operation. They may be ignored. To remove trapped air from the pump head, operate the pump with both speed knob and stroke length knob set at 100.

It may be necessary to disconnect the discharge tubing from the injection point temporarily in order to relieve the pressure on the pump discharge or pull on both knobs of "Anti-Syphon/Pressure Release Assembly" if so equipped. Follow "Priming" instructions in the Liquid Handling Assembly Sheet inserted in this instruction book and operate the pump for a few minutes to purge the head and valves of air or gas.

C. Air leak through valve seal rings - usually caused by worn or damaged seal rings or loose fittings. Tighten fittings by hand until they are very snug. If there is no improvement, replace both seal rings in pump head. See enclosed Liquid Handling Assembly Sheet.

D. Clogged Liquid End - will cause low pump output. Disassemble Liquid End. Clean individual parts with water and detergent or appropriate cleaning solution.

## II. CHANGING LIQUIFRAM™

A. Make sure size code markings on spacer and Liquifram™ (diaphragm) are the same. Liquifram™ and spacer size code must match for the pump to function.

**Always wear protective clothing, gloves and face shield when working on or near solution metering pumps.**

B. Depressurize discharge line following steps outlined in the supplement "Liquid Handling Assembly" Instructions.

Lift foot valve from solution and let pump run pumping air for a few minutes. Then remove pump head.

C. Set stroke length knob (lower knob) to zero and rotating it counter-clockwise  with the pump switched on, then stop the pump by turning selector switch to "EXT" (be sure the pump is disconnected from any external device).

D. Lift edge of Liquifram™ and rotate it counter-clockwise  to unscrew.

E. Before installing new pumping Liquifram™ switch pump on and rotate stroke length control knob (lower knob) to the proper setting per the table following.

Model	Stroke Setting Length
J54D	90
J55D	90
J56D	90

With pump stroking, screw on new pumping Liquifram™ until the center part begins to buckle inwards during the latter half of the stroke. Switch pump off and check Liquifram™ position with a straight edge according to the illustration below.

If Liquifram™ setting is not correct, restart pump, then screw the Liquifram™ in or out. Repeat procedure if necessary. After Liquifram™ is set properly, turn stroke knob to 100%.

F. Reinstall pump head and tighten head mounting screw in criss-cross pattern.

## V. EXCESSIVE PUMP OUTPUT:

A. Syphoning - will cause excessive pump output. Check to be sure back pressure spring is in place in the injection check valve, and that the seal ring is in good condition. Liquid Ends with a suffix "S" have a diaphragm type anti-syphon valve which prevents syphoning and over-pumping but does not affect pump pressure rating.

B. Incorrect knob setting - check stroke length knob (lower knob) by rotating it counter-clockwise  to zero position. The pumping diaphragm should stop reciprocating. If it does not, continue counter-clockwise rotation until motion stops. Reset knob if necessary.

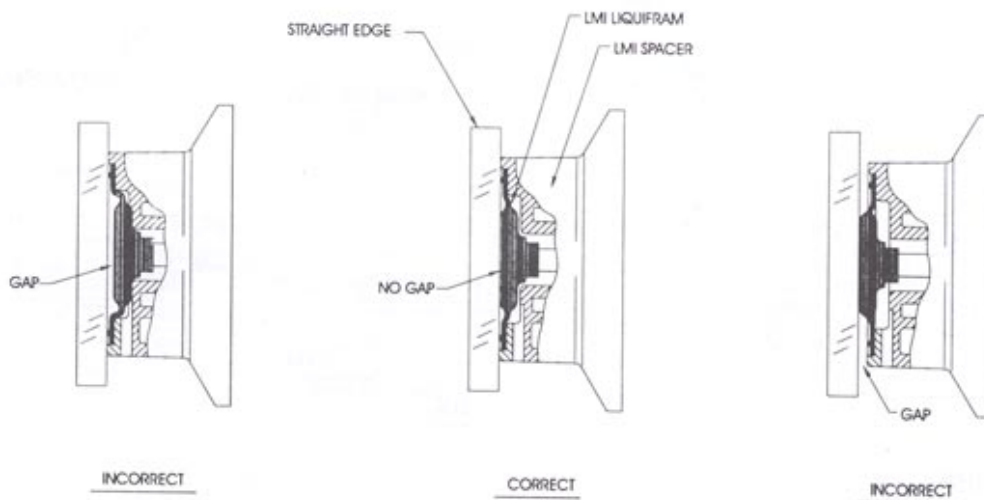

## TROUBLE SHOOTING-ELECTRICAL

**Note:** All tests should be conducted with pump head and Liquifram™ installed. If pump head is removed, it is normal for Liquifram™ shaft to sometimes hang forward and not pulsate if speed is at or near maximum.

I. Connect pump into appropriate 12 VDC power supply being careful of polarity.

- A. Set speed knob (upper knob) to 100.
- B. Set stroke knob (lower knob) to 100.

II. Listen for pulsation.

- A. Check fuse. If blown replace with **20 amp fuse only**. Do not increase or decrease ampere rating.
- B. If pump pulsates 95 to 110 times per minute, electronic pulser module is working correctly.
- C. If pilot light stays on, go to step III.
- D. If pilot light stays off, go to step IV.
- E. If pump pulsates faster than 110 times per minute, pulser module is defective and should be replaced.
- F. If pump pulsates slower than 95 per minute, go to step V.

III. Disconnect pump and remove EPU assembly from housing. The EPU is secured by 4 screws. Check that all electrical connections are tight and correspond to the wiring diagram on this page. Also check that no corrosion has formed around the connections. If wiring is satisfactory, proceed as follows.

- A. Disconnect yellow solenoid wires from pulser module terminal 5 (YEL SOL+ RED Light) and terminal 3 (YEL SOL - WHT LT)

B. Measure the resistance across the EPU wires. Resistance readings should be 1.0 to 1.2 ohms. If resistance readings are OK, the problem is the pulser module which should be replaced.

C. Coil resistances other than 1.0 to 1.2 ohms indicate that the EPU is defective and should be replaced.

IV. Check voltage at battery. 11.8 to 14 VDC is normal. If battery voltage is OK proceed as follows:

A. Remove EPU and check wiring as in step III above.

B. If wiring is OK, carefully connect to battery. **USING EXTREME CAUTION**, measure voltage between pulser terminal 1 (RED+) and pulser terminal 2 (BLK-). If it reads zero volts, input wiring or fuse is defective.

C. If terminals 1 and 2 of pulser are getting proper voltage and solenoid is clicking, pilot light is defective and should be replaced.

D. If solenoid is not clicking, disconnect from battery. Remove speed control wires from terminals labeled 4 (GRY SWITCH) and 6 (RED POT) of pulser. Measure resistance across these wires while rotating speed knob. Resistance should read from 1 megohm to 0 Ohms as knob is rotated clockwise. If the resistance is not correct, replace the potentiometer. If the resistance checks out OK, the pulser is defective and should be replaced.

V. If pump pulsates slower than 95 times per minute, disconnect battery. Remove EPU from housing and check wiring as in step III. If wiring is OK, go to step IV D.

### WIRING DIAGRAM J54D, J55D, J56D

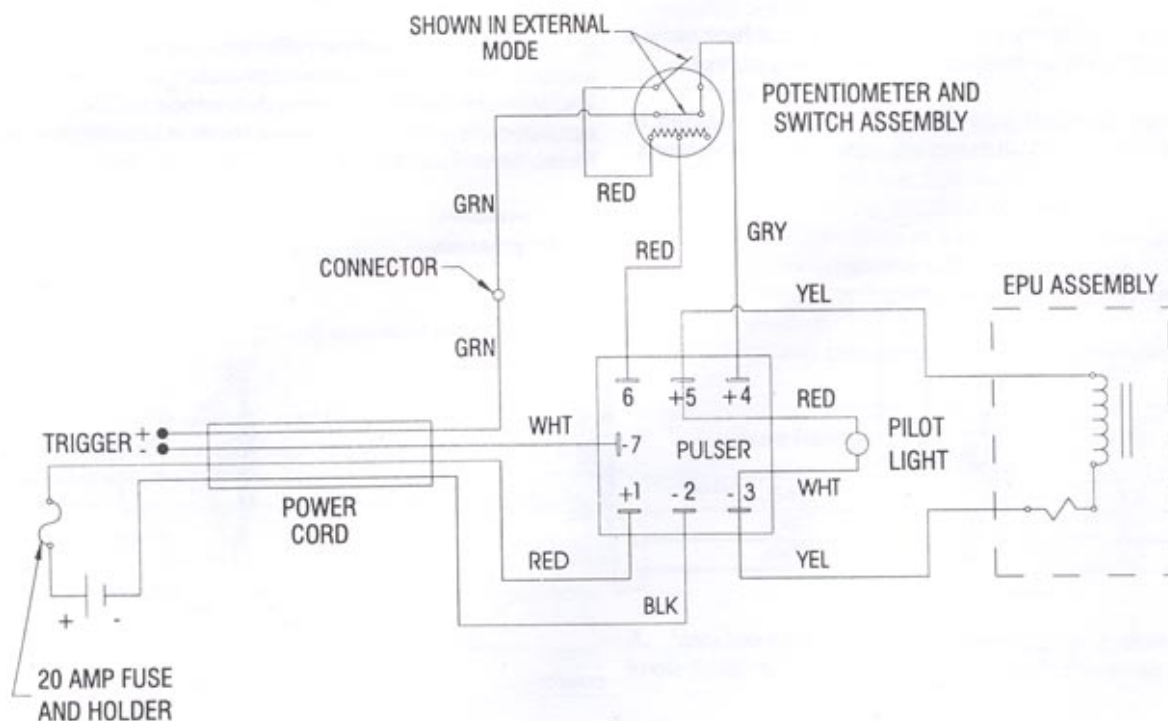

**PULSER TERMINALS**

NO.	LABEL	FUNCTION
1	RED +	DC Positive +
2	BLK -	DC Negative -
3	YEL SOL - WHT LT	EPU and Pilot Light
4	GRY SWITCH	Speed Control & EXT Control
5	YEL SOL + RED LT	EPU & Pilot Light
6	RED POT	Speed Control
7	EXT WHT	EXT Control

## J54D, J55D, J56D PARTS LIST

*see page 8 for exploded view drawing*

Key No.	Part No.	Description	Quantity		
			J54D	J55D	J56D
1	30306	Screw	4	4	4
2	34545	EPU Assembly w/Disk			1
	32038	EPU Assembly w/Disk	1		
	32039	EPU Assembly w/Disk		1	
3	29442	Disk 1.8			1
	29437	Disk 0.9		1	
	29445	Disk 0.5	1		
4	10973	Seal	1	1	1
5	10166	O-Ring	1	1	1
6	32040	Housing & Pulser Assembly	1	1	1
7	32037	Housing Assembly	1	1	1
8	10422	Ring , Retaining	1	1	1
9	25963	Washer, Flat	1	1	1
10	30391	Washer, Rubber	1	1	1
11	32428	Potentiometer Assembly	1	1	1
12	30955	Pulser	1	1	1
13	25414	Spring	1	1	1
15	30709	Knob	1	1	1
16	30295	Knob	1	1	1
17	29837	Stroke Dial	1		1
	29838	Stroke Dial		1	
18	25957-1	Strain Relief	1	1	1
19	10240	Terminal	2	2	2
20	31585	Fuse Holder	1	1	1
21	26412	Fuse, 20 Amp	1	1	1
22	31664	Label	1	1	1
23	26570	Cord	1	1	1
24	31595	Cord Assembly	1	1	1
25	28742	Pilot Light	1	1	1
26	10182-1	Terminal	2	2	2
27	30803	Gasket	1	1	1

