

**CAUTION**

When pumping chemicals make certain that all tubing is securely attached to the fittings. It is recommended that tubing or pipe lines be shielded to prevent possible injury in case of rupture or accidental damage. Always wear protective clothing when working on or near chemical metering pumps.

## NUMBER 21 LIQUID HANDLING ASSEMBLY

For use on LMI Series C  
chemical metering pumps.

### A. INSTALLING INJECTION CHECK VALVE

1. The injection check valve should always be installed as close as possible to the point of chemical injection, at the very end of the tubing run.

**CAUTION**

*Do not operate pump using 21 Liquid Handling Assembly without injection check valve properly installed.*

2. Purpose of injection check valve is to prevent backflow from *treated line* through the relief line of chemical metering pump.
3. A ½" NPT female connection or tee will accept the injection check valve.
4. In order to insure correct seating of the ball inside the check valve, the injection check valve should be installed upwards in the direction of arrows indicating flow.

1. Route tubing from injection check valve to chemical metering pump making sure it does not touch hot surfaces, sharp surfaces, or is bent so sharply that it kinks.
2. Slide small end of coupling nut onto tubing.
3. Push tubing over tapered nozzle of pump head so that tubing flares out and reaches the shoulder. (If tubing is stiff from cold, dip end in hot water).
4. Slide down the coupling nut until threads are engaged. Tighten by hand until tubing is held securely in place.

**CAUTION**

*Excessive force will crack or distort fittings. Do not use pipe wrench.*

### B. CONNECTING DISCHARGE TUBING

Note: Discharge tubing is relatively stiff translucent Polyethylene tubing 10 ft. (3 m) long.

5. Follow the same procedure for connecting tubing to injection check valve.



**LIQUID METRONICS INCORPORATED**  
3 JONES ROAD, WALTHAM, MASS. 02154 USA  
(617) 891-0690 TLX 92-3478

Specifications subject to change without notice.  
Printed in U.S.A.

1042A  
3C179

**C. CONNECTING SUCTION TUBING**

Note: Suction tubing is soft transparent vinyl tubing 6 ft. (1.8 m) long.

1. Cut suction tubing to length necessary between suction valve of chemical metering pump and foot valve. Foot valve should just sit at the bottom of chemical container. Maximum recommended *vertical* suction lift is 5 ft. (1.5 m).
2. Follow same procedure (see B) in connecting suction tubing to suction valve and foot valve.
3. If a suction tube straightner is desired, one may be fabricated from a 3 ft. (1 m) piece of 3/4" Schedule 80 PVC pipe.
4. Dip end of PVC pipe in hot water for at least 1 minute.
5. Push pipe over small end of coupling nut.

**D. CONNECTING RETURN TUBING**

Note: Return tubing is soft transparent tubing, 3/8" (10 mm) O.D., 3 ft. (1 m) long.

1. Insert one end of tubing into elbow connector and tighten white coupling nut.
2. Route other end of tubing beside suction tubing and cut it so that its end is just above the highest level chemical would be in the chemical supply tank. It is important that return tubing end is *not* dipped into the chemical.

**E. PRIMING**

**CAUTION**

*Check injection check valve and make sure it is properly installed before attempting to prime the pump.*

1. Correct position of relief and anti-syphon indicators are:  
 Anti-syphon arrow must be vertical (word "Anti-Syphon" is upright).  
 Relief arrow must be horizontal. (word "Relief" is upright).
2. If arrows are not in these positions rotate so they are as shown below.

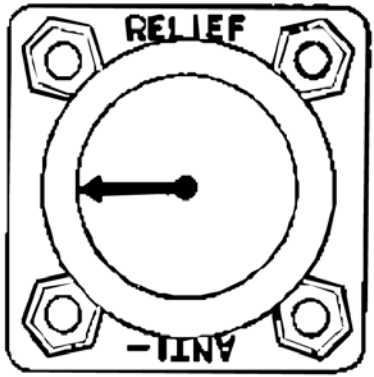

3. Start chemical metering pump and adjust output settings to maximum. If pump does not prime, most likely pump head and valves are dry. Remove complete discharge and anti-syphon valve and pour a small amount of chemical into pump head. Repeat above procedure.
4. When chemical is beginning to flow through the return tubing, rotate relief arrow to the vertical position.

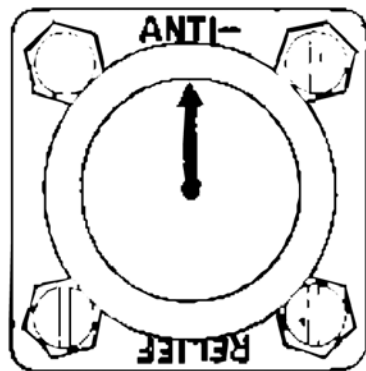

5. The chemical metering pump will now pressurize the discharge tubing and inject chemical into the injection point. At injection pressures below 25 psi (1.75 kg/cm<sup>2</sup>) a slight buzzing noise may be made by the anti-syphon valve during each stroke of electric motor driven chemical metering pumps. This is normal.

**F. DEACTIVATING ANTI-SYPHON**

1. Although it is recommended that anti-syphon action is used, it may be deactivated if desired.

**CAUTION**

*Do not deactivate anti-syphon valve if pressure at injection point is less than 20 psi (1.4 kg/cm<sup>2</sup>) with electronic metering pumps, otherwise over-pumping will occur.*

2. Rotate anti-syphon arrow to horizontal position.

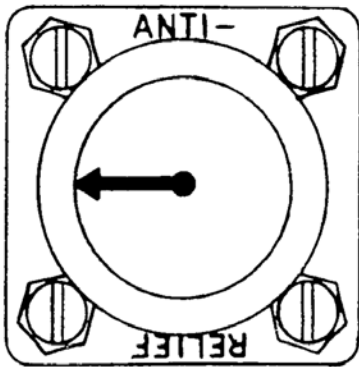

3. Anti-syphon valve no longer operates and if syphoning condition exists at point of injection, most likely chemical from the tank will be syphoned out.

#### G. DEPRESSURIZING DISCHARGE LINE

1. It is possible to depressurize discharge line and pump head without removal of tubing or loosening of fittings.

#### CAUTION

*Be sure injection check valve is properly installed and is operating. If a gate valve or globe had been installed, downstream of injection check valve, it should be closed.*

2. Rotate both anti-syphon and relief arrows so they are in horizontal position as shown below.

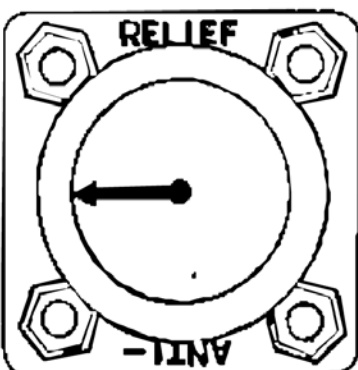
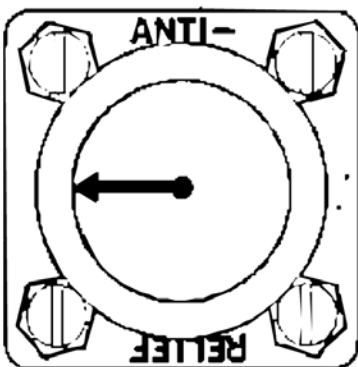

3. The discharge line is now depressurized.
4. If injection check valve is of higher elevation than pump head, disconnecting tubing at injection check valve end will allow air to enter and cause chemical to drain back to the tank.

#### H. DISASSEMBLY OF LIQUID HANDLING COMPONENTS

1. If chemical metering pump is to be removed from its location or to be used for pumping a different chemical than what it has been pumping, the head and valves should be flushed with water or other cleaning fluid not harmful to chemical treatment or pump parts.
2. Switch off chemical metering pump.
3. Lift foot valve from chemical pump and immerse in a 2 gallon (8-10 ℓ) pail of water or detergent solution. Make sure return line points downwards towards the pail.
4. Rotate relief arrow to horizontal position.

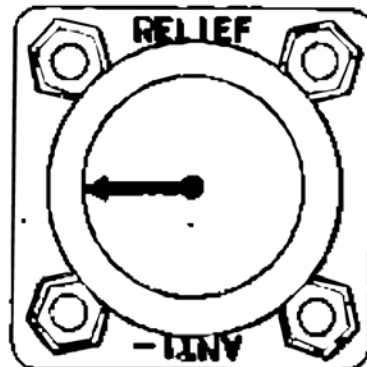

5. Start chemical metering pump and run at full output for about 2 minutes. Water or detergent solution will recirculate through the head and out the return line.
6. The pump head may now be removed by unscrewing the four head mounting screws.
7. Injection check valve should be removed only if point of injection has a hand operated valve which can be closed or no water or fluid would drain back from the line. Use plastic or rubber jaw channel lock pliers to unscrew injection check valve.

# PARTS LIST NO. 21 LIQUID HANDLING ASSEMBLY

Key No.	Part No.	Description	Quantity
1	10151	Injection Check Valve Assy	1
2	10108	Injector Fitting, Plexiglas	1
3*	10109	Flapper, brown Hytrel	1
4*	10138	Ball, glass	4
5	25124	Diaphragm Cap Assembly	2
6*	10128	Seal Ring, Hypalon, green dot	3
7	10106	Valve Seat, Plexiglas	2
8	10111	Coupling Nut, Plexiglas	4
9	10142	Tubing, Polyethylene	10 ft. (3 m)
10	10588	Head Assy, LE 21	1
11	10573	Valve Body, Plexiglas	1
12*	10129	Diaphragm, Hypalon, green dot	2
13	10145	Pin	2
14	10117	Pull Rod	2
15	10139	Spring	2
16	10112	Diaphragm Cap, Plexiglas	2
17	10140	Screw, 10-24 x 1 5/8"	4

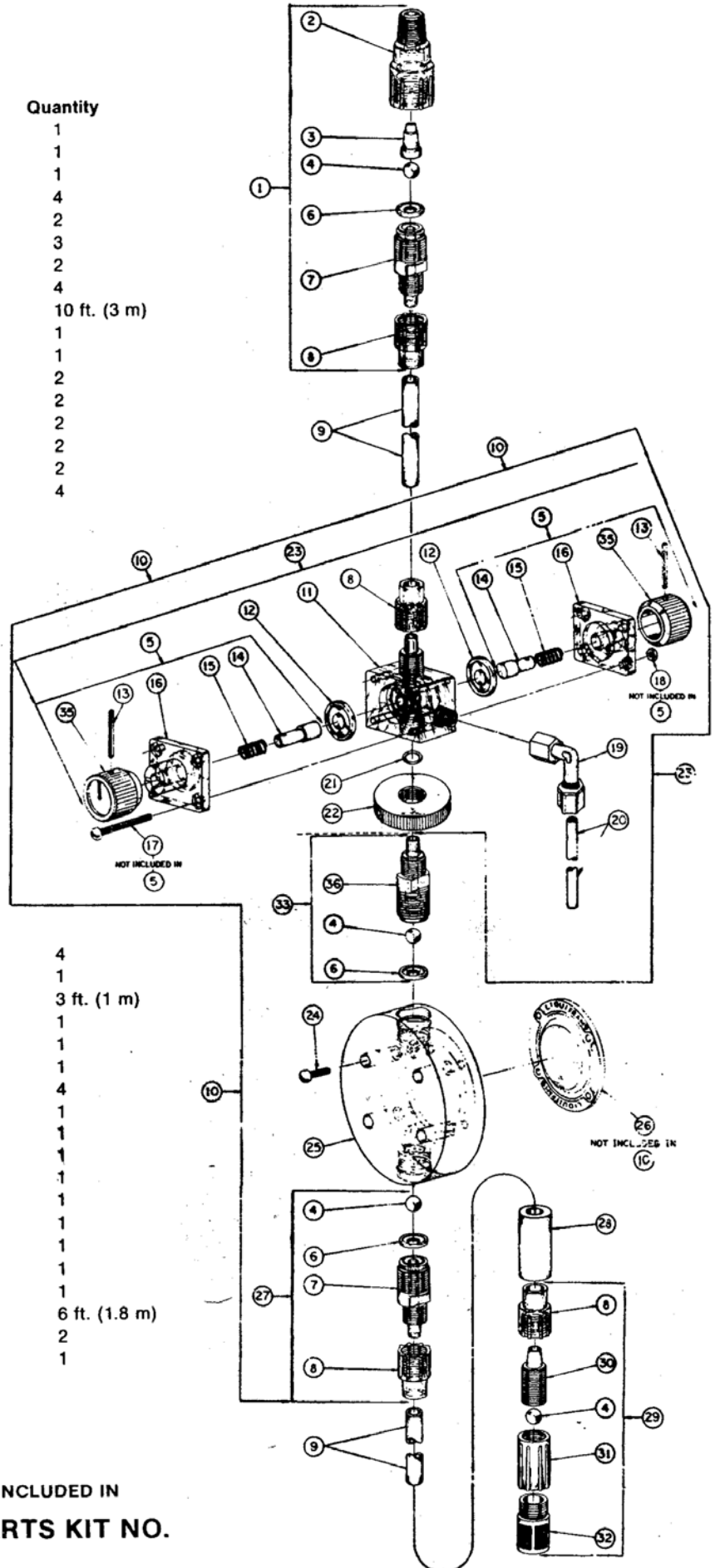

18	10143	Nut, 10-24	4
19	10587	Elbow Connector, Polypropylene	1
20	10469	Return Tubing, Vinyl	3 ft. (1 m)
21*	10572	O-ring, Viton	1
22	10575	Jam Nut, grey PVC	1
23	10565	Anti-syphon Valve Assy, LE 21	1
24	10340	Screw, 10-24 x 3/4, S.S.	4
25	10524	Head, 3.0 SI, Plexiglas	1
26*	25119	Liquifram, 3.0 SI, Hypalon	1
27	10562	Suction Valve Assy, LE 20, 21	1
28	10322	Weight, ceramic	1
29	10153	Foot Valve Assy	1
30	10122	Fitting	1
31	10310	Foot Valve Seat, green Tefzel	1
32	10123	Strainer, white Polypropylene	1
33	10561	Discharge Valve Assy, LE 20, 21	1
34	10141	Tubing	6 ft. (1.8 m)
35	25118	Knob Assembly	2
36	10164	Valve Housing, Plexiglas	1

\* PARTS INCLUDED IN  
**SPARE PARTS KIT NO.  
SP-21**